

# 49BDL3050Q

## V1.00



[www.philips.com/welcome](http://www.philips.com/welcome)

User Manual (English)

**PHILIPS**

**Signage**Solutions

# Safety Instructions

## Safety precautions and maintenance



**WARNING:** Use of controls, adjustments or procedures other than those specified in this documentation may result in exposure to shock, electrical hazards and/or mechanical hazards.

### Read and follow these instructions when connecting and using your display:

#### Operation:

- Keep the display out of direct sunlight and away from stoves or any other heat sources.
- Remove any object that could fall into ventilation holes or prevent proper cooling of the display's electronics.
- Do not block the ventilation holes on the cabinet.
- When positioning the display, make sure the power plug and outlet are easily accessible.
- When turning off the display by detaching the power cord, wait 6 seconds before re-attaching the power cord for normal operation.
- Ensure the use of an approved power cord provided by Philips at all times. If your power cord is missing, please contact your local service center.
- Do not subject the display to severe vibration or high impact conditions during operation.
- Do not knock or drop the display during operation or transportation.
- The eye bolt is for usage in short-time maintenance and installation. We suggest not to use the eye bolt for more than 1 hour. Prolong usage is prohibited. Please keep a clear safety area under the display while using the eye bolt.

#### Maintenance:

- To protect your display from possible damage, do not put excessive pressure on the LCD panel. When moving your display, grasp the frame to lift; do not lift the display by placing your hand or fingers on the LCD panel.
- Unplug the display if you are not going to use it for an extensive period of time.
- Unplug the display if you need to clean it with a slightly damp cloth. The screen may be wiped with a dry cloth when the power is off. However, never use organic solvent, such as, alcohol, or ammonia-based liquids to clean your display.
- To avoid the risk of shock or permanent damage to the set, do not expose the display to dust, rain, water or an excessively moist environment.
- If your display becomes wet, wipe it with dry cloth as soon as possible.
- If a foreign substance or water gets in your display, turn the power off immediately and disconnect the power cord. Then remove the foreign substance or water, and send the unit to the maintenance center.
- Do not store or use the display in locations exposed to heat, direct sunlight or extreme cold.
- In order to maintain the best performance of your display and ensure a longer lifetime, we strongly recommend using the display in a location that falls within the following temperature and humidity ranges.
  - Temperature: 0-40°C 32-104°F
  - Humidity: 20-80% RH
- LCD panel temperature need to be 25 degrees Celsius at all time for better luminance performance.

**IMPORTANT:** Always activate a moving screen saver program when you leave your display unattended. Always activate a periodic screen refresh application if the unit will display unchanging static content. Uninterrupted display of still or static images over an extended period may cause "burn in", also known as "after-imaging" or "ghost imaging", on your screen. This is a well-known phenomenon in LCD panel technology. In most cases, the "burned in" or "after-imaging" or "ghost imaging" will disappear gradually over a period of time after the power has been switched off.

**WARNING:** Severe "burn-in" or "after-image" or "ghost image" symptoms will not disappear and cannot be repaired. This is also not covered under the terms of your warranty.

#### Service:

- The casing cover should be opened only by qualified service personnel.
- If there is any need for repair or integration, please contact your local service center.
- Do not leave your display under direct sunlight.



If your display does not operate normally, having followed the instructions set out in this document, please contact a technician or your local service center.

## Read and follow these instructions when connecting and using your display:



- Unplug the display if you are not going to use it for an extensive period of time.
- Unplug the display if you need to clean it with a slightly damp cloth. The screen may be wiped with a dry cloth when the power is off. However, never use alcohol, solvents or ammonia-based liquids.
- Consult a service technician if the display does not operate normally when you have followed the instructions in this manual.
- The casing cover should be opened only by qualified service personnel.
- Keep the display out of direct sunlight and away from stoves or any other heat sources.
- Remove any object that could fall into the vents or prevent proper cooling of the display's electronics.
- Do not block the ventilation holes on the cabinet.
- Keep the display dry. To avoid electric shock, do not expose it to rain or excessive moisture.
- When turning off the display by detaching the power cable or DC power cord, wait for 6 seconds before re-attaching the power cable or DC power cord for normal operation.
- To avoid the risk of shock or permanent damage to the set do not expose the display to rain or excessive moisture.
- When positioning the display, make sure the power plug and outlet are easily accessible.
- **IMPORTANT:** Always activate a screen saver program during your application. If a still image in high contrast remains on the screen for an extended period of time, it may leave an 'after-image' or 'ghost image' on the front of the screen. This is a well-known phenomenon that is caused by the shortcomings inherent in LCD technology. In most cases the afterimage will disappear gradually over a period of time after the power has been switched off. Be aware that the after-image symptom cannot be repaired and is not covered under warranty.

## EU Declaration of Conformity

This device complies with the requirements set out in the Council Directive on the Approximation of the Laws of the Member States relating to Electromagnetic Compatibility (2014/30/EU), Low-voltage Directive (2014/35/EU), RoHS directive (2011/65/EU).

This product has been tested and found to comply with the harmonized standards for Information Technology Equipment, these harmonized standards published under Directives of Official Journal of the European Union.

## ESD Warnings

When user close to the monitor may cause the equipment discharge and reboot to the display of main menu.

### Warning:

This equipment is compliant with Class A of EN55032/CISPR 32. In a residential environment this equipment may cause radio interference.

## Federal Communications Commission (FCC) Notice (U.S. Only)



**NOTE:** This equipment has been tested and found to comply with the limits for a Class A digital device, pursuant to part 15 of the FCC Rules. These limits are designed to provide reasonable protection against harmful interference when the equipment is operated in a commercial environment. This equipment generates, uses, and can radiate radio frequency energy and, if not installed and used in accordance with the instruction manual, may cause harmful interference to radio communications. Operation of this equipment in a residential area is likely to cause harmful interference in which case the user will be required to correct the interference at his own expense.



Changes or modifications not expressly approved by the party responsible for compliance could void the user's authority to operate the equipment.

Use only an RF shielded cable that was supplied with the display when connecting this display to a computer device.

To prevent damage which may result in fire or shock hazard, do not expose this appliance to rain or excessive moisture.

This device complies with Part 15 of the FCC Rules. Operation is subject to the following two conditions: (1) This device may not cause harmful interference, and (2) this device must accept any interference received, including interference that may cause undesired operation.

## Canada:

Industry Canada statement:

This device complies with RSS-247 of the Industry Canada Rules. Operation is subject to the following two conditions: (1) This device may not cause harmful interference, and (2) this device must accept any interference received, including interference that may cause undesired operation.

Ce dispositif est conforme à la norme CNR-247 d'Industrie Canada applicable aux appareils radio exempts de licence. Son fonctionnement est sujet aux deux conditions suivantes: (1) le dispositif ne doit pas produire de brouillage préjudiciable, et (2) ce dispositif doit accepter tout brouillage reçu, y compris un brouillage susceptible de provoquer un fonctionnement in

## Brazil:

ANATEL RF STATEMENT

Per Article 6 of Resolution 506, equipment of restricted radiation must carry the following statement in a visible location

"Este equipamento opera em caráter secundário, isto é, não tem direito a proteção contra interferência prejudicial, mesmo de estações do mesmo tipo, e não pode causar interferência a sistemas operando em caráter primário."

ANATEL BODY SAR STATEMENT

"Este produto atende aos requisitos técnicos aplicados, incluindo os limites de exposição da Taxa de Absorção Específica referente a campos elétricos, magnéticos e eletromagnéticos de radiofrequência, de acordo com as resoluções nº303/2002 e 533/2009. Este produto atende às diretrizes de exposição à RF na posição normal de uso a pelo menos X centímetros longe do corpo, tendo sido os ensaios de SAR para corpo realizado a X cm de acordo com o informativo de recomendação apresentado no manual do fabricante."

## Polish Center for Testing and Certification Notice

The equipment should draw power from a socket with an attached protection circuit (a three-prong socket). All equipment that works together (computer, display, printer, and so on) should have the same power supply source.

The phasing conductor of the room's electrical installation should have a reserve short-circuit protection device in the form of a fuse with a nominal value no larger than 16 amperes (A).

To completely switch off the equipment, the power supply cable must be removed from the power supply socket, which should be located near the equipment and easily accessible.

A protection mark "B" confirms that the equipment is in compliance with the protection usage requirements of standards PN-93/T-42107 and PN-89/E-06251.

### ***Wymagania Polskiego Centrum Badań i Certyfikacji***

Urządzenie powinno być zasilane z gniazda z przyłączonym obwodem ochronnym (gniazdo z kolkiem). Współpracujące ze sobą urządzenia (komputer, monitor, drukarka) powinny być zasilane z tego samego źródła.

Instalacja elektryczna pomieszczenia powinna zawierać w przewodzie fazowym rezerwową ochronę przed zwarciami, w postaci bezpiecznika o wartości znamionowej nie większej niż 16A (amperów).

W celu całkowitego wyłączenia urządzenia z sieci zasilania, należy wyjąć wtyczkę kabla zasilającego z gniazdka, które powinno znajdować się w pobliżu urządzenia i być łatwo dostępne.

Znak bezpieczeństwa "B" potwierdza zgodność urządzenia z wymaganiami bezpieczeństwa użytkowania zawartymi w PN-93/T-42107 i PN-89/E-06251.

### ***Pozostałe instrukcje bezpieczeństwa***

- Nie należy używać wtyczek adapterowych lub usuwać kolka obwodu ochronnego z wtyczki. Jeżeli konieczne jest użycie przedłużacza to należy użyć przedłużacza 3-żyłowego z prawidłowo połączonym przewodem ochronnym.
- System komputerowy należy zabezpieczyć przed nagłymi, chwilowymi wzrostami lub spadkami napięcia, używając eliminatora przepięć, urządzenia dopasowującego lub bezzakłóceniewego źródła zasilania.
- Należy upewnić się, aby nic nie leżało na kablach systemu komputerowego, oraz aby kable nie były umieszczone w miejscu, gdzie można byłoby na nie nadeptywać lub potykać się o nie.
- Nie należy rozlewać napojów ani innych płynów na system komputerowy.
- Nie należy wpychać żadnych przedmiotów do otworów systemu komputerowego, gdyż może to spowodować pożar lub porażenie prądem, poprzez zwarcie elementów wewnętrznych.
- System komputerowy powinien znajdować się z dala od grzejników i źródeł ciepła. Ponadto, nie należy blokować otworów wentylacyjnych. Należy unikać kładzenia luźnych papierów pod komputer oraz umieszczania komputera w ciasnym miejscu bez możliwości cyrkulacji powietrza wokół niego.



## Electric, Magnetic and Electromagnetic Fields (“EMF”)

1. We manufacture and sell many products targeted at consumers, which, like any electronic apparatus, in general have the ability to emit and receive electromagnetic signals.
2. One of our leading Business Principles is to take all necessary health and safety measures for our products, to comply with all applicable legal requirements and to stay well within the EMF standards applicable at the time of producing the products.
3. We are committed to develop, produce and market products that cause no adverse health effects.
4. We confirm that if its products are handled properly for their intended use, they are safe to use according to scientific evidence available today.
5. We play an active role in the development of international EMF and safety standards, enabling us to anticipate further developments in standardization for early integration in its products.

### Information for U.K. only

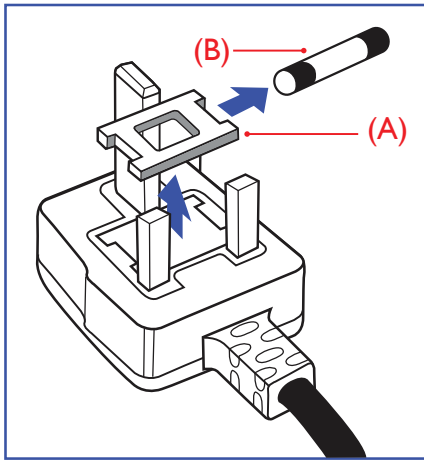

#### **WARNING - THIS APPLIANCE MUST BE EARTHED.**

##### **Important:**

This apparatus is supplied with an approved moulded 13A plug. To change a fuse in this type of plug proceed as follows:+

1. Remove fuse cover and fuse.
2. Fit new fuse which should be a BS 1362 5A, A.S.T.A. or BSI approved type.
3. Refit the fuse cover.

If the fitted plug is not suitable for your socket outlets, it should be cut off and an appropriate 3-pin plug fitted in its place.

If the mains plug contains a fuse, this should have a value of 5A. If a plug without a fuse is used, the fuse at the distribution board should not be greater than 5A.

NOTE: The severed plug must be destroyed to avoid a possible shock hazard should it be inserted into a 13A socket elsewhere.

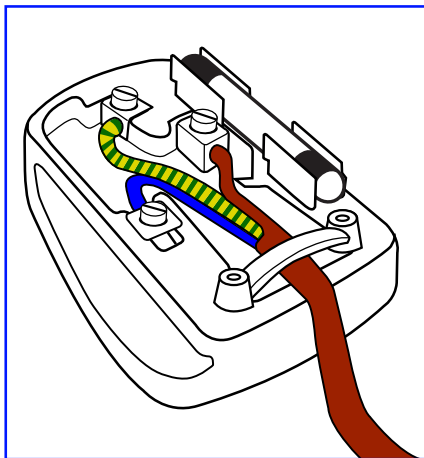

##### **How to connect a plug**

The wires in the mains lead are coloured in accordance with the following code:

- BLUE - “NEUTRAL” (“N”)
- BROWN - “LIVE” (“L”)
- GREEN & YELLOW - “EARTH” (“E”)

1. The GREEN & YELLOW wire must be connected to the terminal in the plug which is marked with the letter “E” or by the Earth symbol or coloured GREEN or GREEN & YELLOW.
2. The BLUE wire must be connected to the terminal which is marked with the letter “N” or coloured BLACK.
3. The BROWN wire must be connected to the terminal which marked with the letter “L” or coloured RED.

Before replacing the plug cover, make certain that the cord grip is clamped over the sheath of the lead - not simply over the three wires.

### North Europe (Nordic Countries) Information

Placering/Ventilation

#### **VARNING:**

FÖRSÄKRA DIG OM ATT HUVUDBRYTARE OCH UTTAG ÄR LÄTÅTKOMLIGA, NÄR DU STÄLLER DIN UTRUSTNING PÅPLATS.

Placering/Ventilation

#### **ADVARSEL:**

SØRG VED PLACERINGSFOR, AT NETLEDNINGENS STIK OG STIKKONTAKT ER NEMT TILGÆNGELIGE.

Paikka/Ilmankierto

**VAROITUS:**

SJJOITA LAITE SITEN, ETTÄ VERKKOJOHTO VOIDAAN TARVITTAESSA HELPOSTI IRROTTAA PISTORASIESTA.

Plassering/Ventilasjon

**ADVARSEL:**

NÅR DETTE UTSTYRET PLASSERES, MÅ DU PASSE PÅ AT KONTAKTENE FOR STØMTILFØRSEL ER LETTE Å NÅ.

## China RoHS

根据中国大陆《电子电气产品有害物质限制使用标识要求》，以下部分列出了本产品中可能包含的有害物质的名称和含量。

部件名称	有害物质					
	铅 (Pb)	汞 (Hg)	镉 (Cd)	六价铬 (Cr (VI))	多溴联苯 (PBB)	多溴二苯醚 (PBDE)
外壳	○	○	○	○	○	○
液晶显示屏/灯管	×	×	○	○	○	○
电路板组件*	×	○	○	○	○	○
电源适配器	×	○	○	○	○	○
电源线/连接线	×	○	○	○	○	○
遥控器	×	○	○	○	○	○

本表格依据SJ/T 11364 的规定编制。

\*: 电路板组件包括印刷电路板及其构成的零部件，如电阻、电容、集成电路、连接器等。

○: 表示该有害物质在该部件所有均质材料中的含量均在 GB/T 26572规定的限量要求以下。

×: 表示该有害物质至少在该部件的某一均质材料中的含量超出GB/T 26572规定的限量要求。

上表中打“×”的部件，应功能需要，部分有害物质含量超出GB/T 26572规定的限量要求，但符合欧盟RoHS法规要求（属于豁免部分）。

备注：上表仅做为范例，实际标示时应依照各产品的实际部件及所含有害物质进行标示。



### 环保使用期限

此标识指期限(十年)，电子电气产品中含有的有害物质在正常使用的条件下不会发生外泄或突变，电子电气产品用户使用该电子电气产品不会对环境造成严重污染或对其人身、财产造成严重损害的期限。

## 《废弃电器电子产品回收处理管理条例》提示性说明

为了更好地关爱及保护地球，当用户不再需要此产品或产品寿命终止时，请遵守国家废弃电器电子产品回收处理相关法律法规，将其交给当地具有国家认可的回收处理资质的厂商进行回收处理。

### 警告

此为A级产品。在生活环境中，该产品可能会造成无线电干扰。在这种情况下，可能需要用户对干扰采取切实可行的措施。

單元	限用物質及其化學符號					
	鉛 (Pb)	汞 (Hg)	鎘 (Cd)	六價鉻 (Cr <sup>+6</sup> )	多溴聯苯 (PBB)	多溴二苯醚 (PBDE)
塑料外框	○	○	○	○	○	○
後殼	○	○	○	○	○	○
液晶面板	—	○	○	○	○	○
電路板組件	—	○	○	○	○	○
底座	○	○	○	○	○	○
電源線	—	○	○	○	○	○
其他線材	—	○	○	○	○	○
遙控器	—	○	○	○	○	○

備考1. “○” 係指該項限用物質之百分比含量未超出百分比含量基準值。  
備考2. “—” 係指該項限用物質為排除項目。

警語：使用過度恐傷害視力。

注意事項：

- (1) 使用30分鐘請休息10分鐘。
- (2) 未滿2歲幼兒不看螢幕，2歲以上每天看螢幕不要超過1小時。

警告使用者：

此為甲類資訊技術設備，於居住環境中使用時，可能會造成射頻擾動，在此種情況下，使用者會被要求採取某些適當的對策。

### Turkey RoHS:

Türkiye Cumhuriyeti: EEE Yönetmeliğine Uygundur

### Ukraine RoHS:

Обладнання відповідає вимогам Технічного регламенту щодо обмеження використання деяких небезпечних речовин в електричному та електронному обладнанні, затвердженого постановою Кабінету Міністрів України від 3 грудня 2008 № 1057

## End-of-Life Disposal

Your new Public Information Display contains materials that can be recycled and reused. Specialized companies can recycle your product to increase the amount of reusable materials and to minimize the amount to be disposed of.

Please find out about the local regulations on how to dispose of your old display from your local Philips dealer.

### (For customers in Canada and U.S.A.)

This product may contain lead and/or mercury. Dispose of in accordance to local-state and federal regulations. For additional information on recycling contact [www.eia.org](http://www.eia.org) (Consumer Education Initiative)

## Waste Electrical and Electronic Equipment-WEEE

### Attention users in European Union private households



This marking on the product or on its packaging illustrates that, under European Directive 2012/19/EU governing used electrical and electronic appliances, this product may not be disposed of with normal household waste. You are responsible for disposal of this equipment through a designated waste electrical and electronic equipment collection. To determine the locations for dropping off such waste electrical and electronic, contact your local government office, the waste disposal organization that serves your household or the store at which you purchased the product.

### Attention users in United States:

Please dispose of according to all Local, State and Federal Laws. For the disposal or recycling information, contact: [www.mygreenelectronics.com](http://www.mygreenelectronics.com) or [www.eiae.org](http://www.eiae.org).

### End of Life Directives-Recycling



Your new Public Information Display contains several materials that can be recycled for new users.

Please dispose of according to all Local, State, and Federal laws.



As an ENERGY STAR Partner, we have determined that this product meets the ENERGY STAR guidelines for energy efficiency.

### Restriction on Hazardous Substances statement (India)

This product complies with the "E-Waste (Management) Rules, 2016" CHAPTER V, rule 16, sub-rule (1). Whereas New Electrical and Electronic Equipment and their components or consumables or parts or spares do not contain Lead, Mercury, Cadmium, Hexavalent Chromium, polybrominated biphenyls and polybrominated diphenyl ethers beyond a maximum concentration value of 0.1% by weight in homogenous materials for lead, mercury, hexavalent chromium, polybrominated biphenyls and polybrominated diphenyl ethers and of 0.01% by weight in homogenous materials for cadmium, except of exemptions set in Schedule 2 of the Rule.

### E-Waste Declaration for India



This symbol on the product or on its packaging indicates that this product must not be disposed of with your other household waste. Instead it is your responsibility to dispose of your waste equipment by handing it over to a designated collection point for the recycling of waste electrical and electronic equipment. The separate collection and recycling of your waste equipment at the time of disposal will help to conserve natural resources and ensure that it is recycled in a manner that protects human health and the environment. For more information about E-waste please visit <http://www.india.philips.com/about/sustainability/recycling/index.page> and to know where you can drop off your waste equipment for recycling in India please contact on below given contact details.

Helpline number: 1800-425-6396 (Monday to Saturday, 9 a.m. to 5:30 pm)

Centralized E-waste collection center

Address: TPV Technology India Private Limited,

59, Maheswari Nagar, 1st Main Road, Mahadevapura Post, Whitefield Road

Bangalore, Karnataka, PIN: 560048, Tel: 080-3023-1000

E-mail: [india.callcentre@tpv-tech.com](mailto:india.callcentre@tpv-tech.com)

## Batteries



For EU: The crossed-out wheeled bin implies that used batteries should not be put to the general household waste! There is a separate collection system for used batteries, to allow proper treatment and recycling in accordance with legislation.

Please contact your local authority for details on the collection and recycling schemes.

For Switzerland: The used battery is to be returned to the selling point.

For other non-EU countries: Please contact your local authority for correct method of disposal of the used battery.

**According to EU directive 2006/66/EC, the battery can't be disposed improperly. The battery shall be separated to collect by local service.**

	Após o uso, as pilhas e/ou baterias deverão ser entregues ao estabelecimento comercial ou rede de assistência técnica autorizada.
--	---

Information for EAC	
Month and year of manufacturing	please refer information in Rating label.
Name and location of manufacturer	ООО "Профтехника" Адрес: 3-й Проезд Марьиной роши, 40/1 офис 1. Москва, 127018, Россия
Importer and information	Наименование организации: ООО "Профтехника" Адрес: 3-й Проезд Марьиной роши, 40/1 офис 1. Москва, 127018, Россия Контактное лицо: Наталья Астафьева, +7 495 640 20 20 <a href="mailto:nat@profdisplays.ru">nat@profdisplays.ru</a>

# Table Of Contents

<b>1. Unpacking and Installation</b> .....	<b>1</b>
1.1. Unpacking.....	1
1.2. Package Contents.....	1
1.3. Installation Notes.....	1
1.4. Mounting on a Wall .....	2
<b>2. Parts and Functions</b> .....	<b>3</b>
2.1. Control Panel.....	3
2.2. Input/Output Terminals.....	4
2.3. Using of Remote sensor and power indicator.....	5
2.4. USB Cover.....	7
2.5. Remote Control.....	8
<b>3. Connecting External Equipment</b> .....	<b>12</b>
3.1. Connecting External Equipment (DVD/VCR/ VCD) .....	12
3.2. Connecting a PC.....	12
3.3. Connecting Audio Equipment.....	13
3.4. Connecting Multiple Displays in a Daisy-chain Configuration .....	13
3.5. IR connection .....	14
3.6. IR Pass-through Connection.....	15
<b>4. Operation</b> .....	<b>16</b>
4.1. Watch the Connected Video Source.....	16
4.2. Change Picture Format .....	16
4.3. Overview.....	16
4.4. Media Player introduction:.....	17
4.5. Browser manual.....	19
4.6. PDF reader play.....	22
4.7. CMND & Play.....	24
4.8. Custom App.....	24
<b>5. Signage display</b> .....	<b>26</b>
5.1. Setting.....	26
5.2. Wi-Fi .....	26
5.3. Ethernet.....	26
5.4. Proxy.....	27
5.5. Signage Display.....	27
5.6. System Tools .....	35
5.7. Clone Media File .....	36
5.8. Display .....	37
5.9. Apps.....	37
5.10. Security.....	37
5.11. Date & time .....	37
5.12. Developer options.....	37
5.13. About .....	38
5.14. Supplementary .....	38
<b>6. OSD Menu</b> .....	<b>41</b>
6.1. Navigating the OSD Menu.....	41
6.2. OSD Menu Overview .....	41
<b>7. Supported Media Formats</b> .....	<b>47</b>
<b>8. Input Mode</b> .....	<b>49</b>
<b>9. Pixel Defect Policy</b> .....	<b>50</b>
9.1. Pixels and Sub-Pixels.....	50
9.2. Types of Pixel Defects + Dot Definition .....	50
9.3. Bright Dot Defects.....	50
9.4. Dark Dot Defects.....	51
9.5. Proximity of Pixel Defects .....	51
9.6. Pixel Defect Tolerances .....	51
9.7. MURA.....	51
<b>10. Cleaning and Troubleshooting</b> .....	<b>52</b>
10.1. Cleaning.....	52
10.2. Troubleshooting.....	53
<b>11. Technical Specifications</b> .....	<b>55</b>



# 1. Unpacking and Installation

## 1.1. Unpacking

- This product is packed in a carton, together with the standard accessories.
- Any other optional accessories will be packed separately.
- Due to the size and weight of this display it is recommended for two people to move it.
- After opening the carton, ensure that the contents are complete and in good condition.

## 1.2. Package Contents

Please verify that you received the following items with your package content:

- LCD display
- Quick start guide
- Remote control with AAA batteries
- Power cord
- RS232 cable
- RS232 daisy chain cable
- IR sensor cable
- USB cover and screw x1

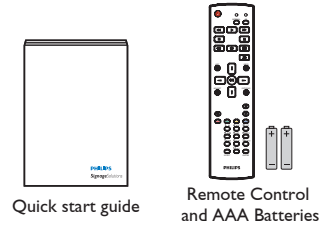
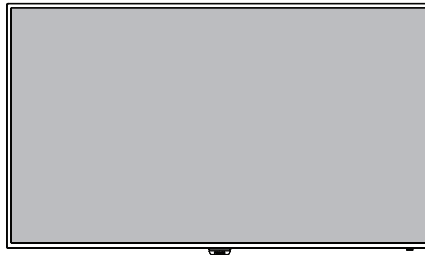

\* The supplied power cord varies depending on destination.

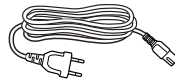

Power Cord

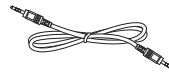

RS232 Daisy Chain Cable

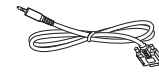

RS232 Cable



IR Sensor Cable



USB Cover



x1

\* Differences according to regions

Display design and accessories may differ from those illustrated above.

NOTES:

- For all other regions, apply a power cord that conforms to the AC voltage of the power socket and has been approved by and complies with the safety regulations of the particular country (Type H05W-F, 2G or 3G, 0.75 or 1 mm<sup>2</sup> should be used).
- You might like to save the package box and packing material for shipping the display.

## 1.3. Installation Notes

- Due to the high power consumption, always use the plug exclusively designed for this product. If an extended line is required, please consult your service agent.
- The product should be installed on a flat surface to avoid tipping. The distance between the back of the product and the wall should be maintained for proper ventilation. Avoid installing the product in the kitchen, bathroom or any other places with high humidity so as not to shorten the service life of the electronic components.
- The product can normally operate only under 3000m in altitude. In installations at altitudes above 3000m, some abnormalities may be experienced.

## 1.4. Mounting on a Wall

To mount this display to a wall, you will have to obtain a standard wall-mounting kit (commercially available). We recommend using a mounting interface that complies with TUV-GS and/or UL1678 standard in North America.

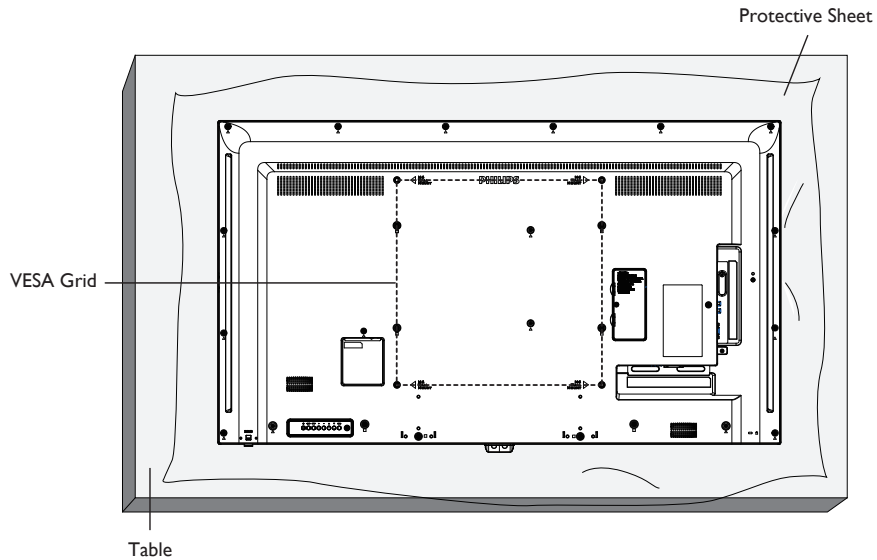

1. Lay a protective sheet on a table, which was wrapped around the display when it was packaged, beneath the screen surface so as not to scratch the screen face.
2. Ensure you have all accessories for mounting this display (wall mount, ceiling mount, table stand, etc).
3. Follow the instructions that come with the base mounting kit. Failure to follow correct mounting procedures could result in damage to the equipment or injury to the user or installer. Product warranty does not cover damage caused by improper installation.
4. For the wall-mounting kit, use M6 mounting screws (having a length 10 mm longer than the thickness of the mounting bracket) and tighten them securely.
5. Unit without base weight= 11.4 kg. The equipment and its associated mounting means still remain secure during the test. For use only with UL Listed Wall Mount Bracket with minimum weight/load: 11.4 kg.
6. Portrait is not allowed.

### 1.4.1. VESA Grid

<b>49BDL3050Q</b>	400(H) × 400(V) mm
-------------------	--------------------

#### Caution:

To prevent the display from falling:

- For wall or ceiling installation, we recommend installing the display with metal brackets which are commercially available. For detailed installation instructions, refer to the guide received with the respective bracket.
- To lessen the probability of injury and damage resulting from fall of the display in case of earthquake or other natural disaster, be sure to consult the bracket manufacturer for installation location.

#### Ventilation Requirements for enclosure locating

To allow heat to disperse, leave space between surrounding objects as shown in the diagram below.

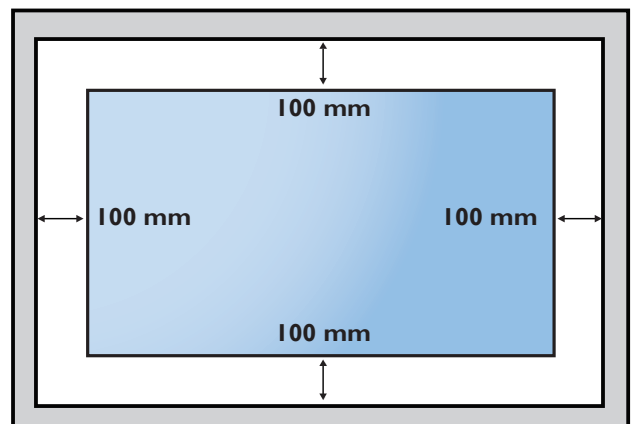

## 2. Parts and Functions

### 2.1. Control Panel

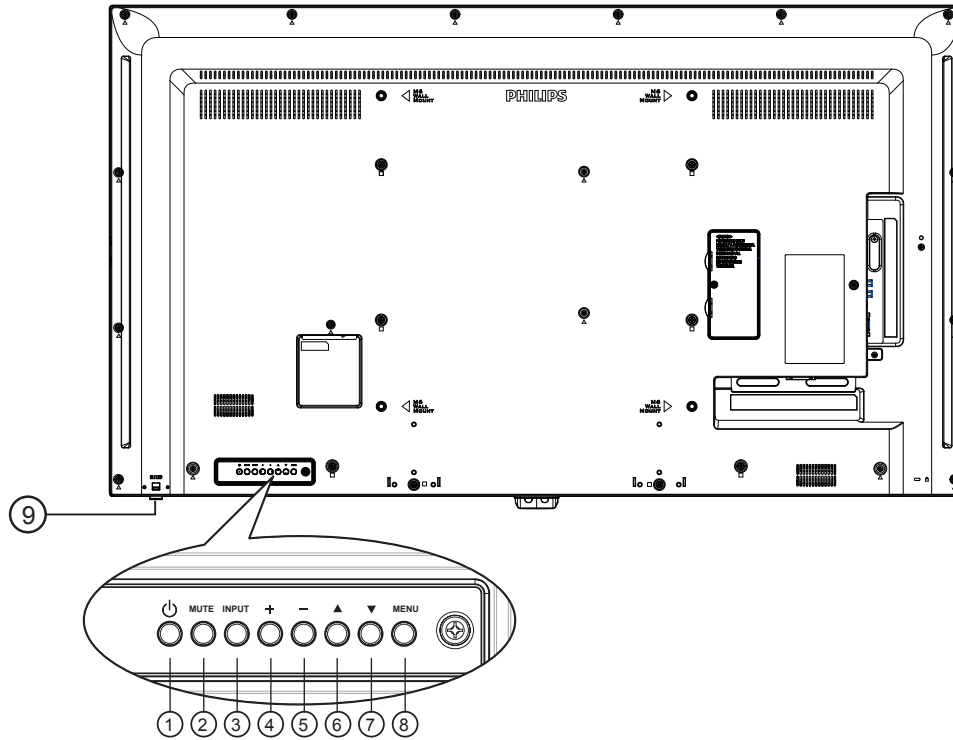

① **[⏻] button**

Use this button to turn the display on or put the display to standby.

② **[MUTE] button**

Switch the audio mute ON/OFF.

③ **[INPUT] button**

Choose the input source.

④ **[+] button**

- Increase the volume
- Enter into submenu while OSD menu is on

⑤ **[-] button**

- Decrease the volume
- Back to previous menu while OSD menu is on

⑥ **[▲] button**

- Move the highlight bar up to adjust the selected item while OSD menu is on
- Increase the adjustment while adjust value.

⑦ **[▼] button**

- Move the highlight bar down to adjust the selected item while OSD menu is on.
- Decrease the adjustment while adjust value.

⑧ **[MENU] button**

Return to previous menu while OSD menu is on, or to activate the OSD menu when OSD menu is off.

⑨ **Remote control sensor and power status indicator**

- Receives command signals from the remote control.
- Indicates the operating status of the display without OPS:
  - Lights green when the display is turned on
  - Lights red when the display is in standby mode
  - When {SCHEDULE} is enabled, the light blinks green and red
  - If the light blinks red, it indicates that a failure has been detected
  - Lights off when the main power of the display is turned off

\* Using IR sensor cable for better remote control performance.  
(Please refer to the instructions of 3.5)

## 2.2. Input/Output Terminals

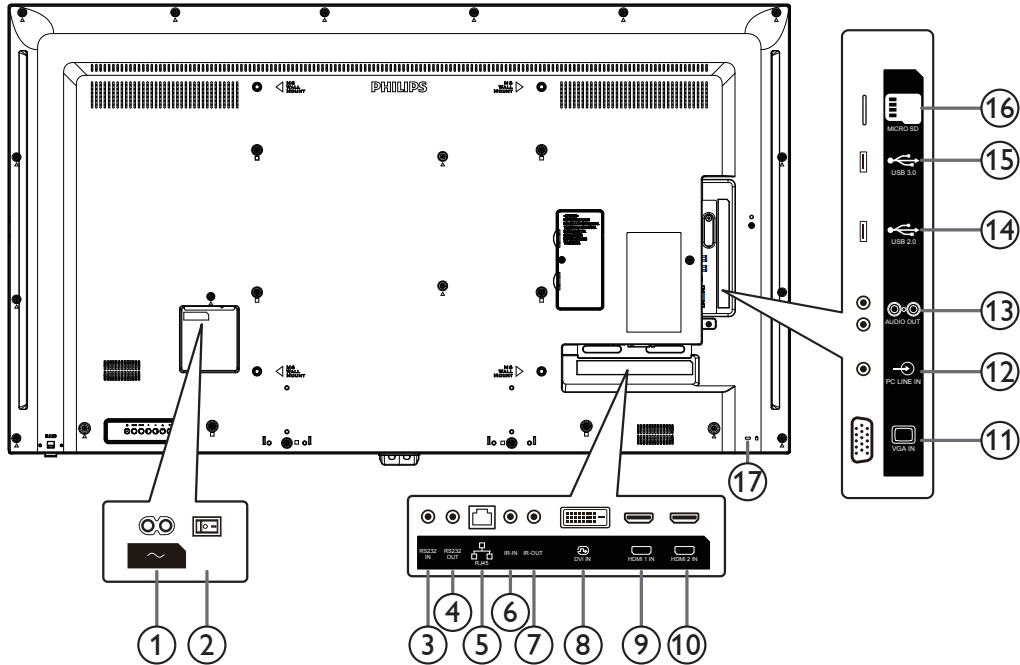

**① AC IN**

AC power input from the wall outlet.

**② MAIN POWER SWITCH**

Switch the main power on/off.

**③ RS232 IN / ④ RS232 OUT**

RS232 network input / output for the loop-through function.

**⑤ RJ-45**

LAN control function for the use of remote control signal from control center.

**⑥ IR IN / ⑦ IR OUT**

IR signal input / output for the loop-through function.

NOTES:

- This display's remote control sensor will stop working if the jack [IR IN] is connected.
- To remotely control your A/V device via this display, refer to page 14 for or IR Pass Through connection.

**⑧ DVI IN**

DVI video input.

**⑨ HDMI1 IN / ⑩ HDMI2 IN**

HDMI video/audio input.

**⑪ VGA IN (D-Sub)**

VGA video input.

**⑫ PC LINE IN**

Audio input for VGA source (3.5mm stereo phone).

**⑬ AUDIO OUT**

Audio output to external AV device.

**⑭ USB 2.0 / ⑮ USB 3.0 PORT**

Connect your USB storage device

**⑯ MICRO SD CARD**

Connect your MICRO SD CARD.

**⑰ SECURITY LOCK**

Used for security and theft prevention.

### 2.2.1. Inserting the batteries in the remote control

The remote control is powered by two 1.5V AAA batteries.

To install or replace batteries:

1. Press and then slide the cover to open it.
2. Align the batteries according to the (+) and (-) indications inside the battery compartment.
3. Replace the cover:

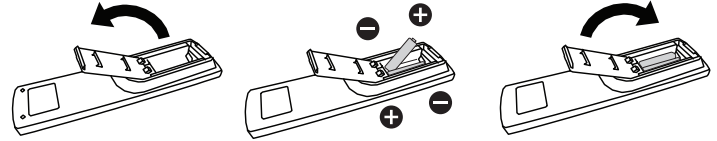

#### Caution:

The incorrect use of batteries can result in leaks or bursting. Be sure to follow these instructions:

- Place “AAA” batteries matching the (+) and (-) signs on each battery to the (+) and (-) signs of the battery compartment.
- Do not mix battery types.
- Do not combine new batteries with used ones. It causes shorter life or leakage of batteries.
- Remove the dead batteries immediately to prevent them from liquid leaking in the battery compartment. Don't touch exposed battery acid, as it can damage your skin.

NOTE: If you do not intend to use the remote control for a long period, remove the batteries.

### 2.2.2. Handling the remote control

- Do not subject to strong shock.
- Do not allow water or other liquid to splash the remote control. If the remote control gets wet, wipe it dry immediately.
- Avoid exposure to heat and steam.
- Other than to install the batteries, do not open the remote control.

### 2.2.3. Operating range of the remote control

Point the top of the remote control toward the display's remote control sensor when pressing a button.

Use the remote control within a distance of less than 6m (pull the lens down and use the remote control from the front) /19ft from the display's sensor; and a horizontal and vertical angle of less than 20 degrees.

NOTE: The remote control may not function properly when the remote control sensor on the display is under direct sunlight or strong illumination, or when there is an obstacle in the path of signal transmission.

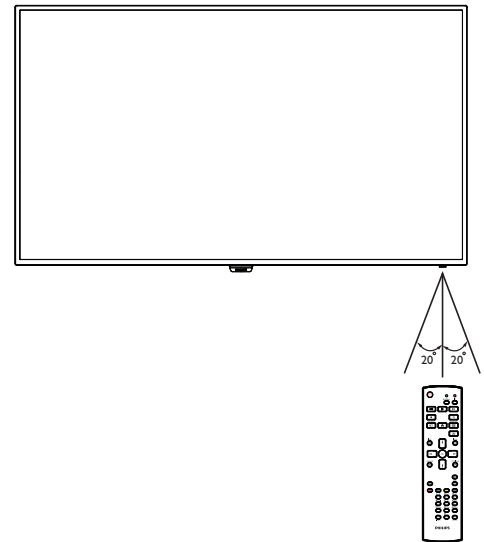

### 2.3. Using of Remote sensor and power indicator

1. Push down the lens to have better remote control performance and easy to observe the light information of power status
2. Pull up the lens before mounting the display for video wall application
3. Pull/Push the lens until hearing the click sound

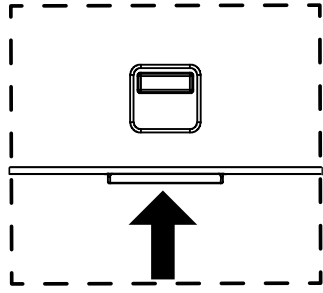

Push up to collapse the lens

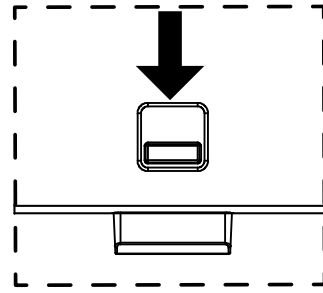

Push down to extend the lens

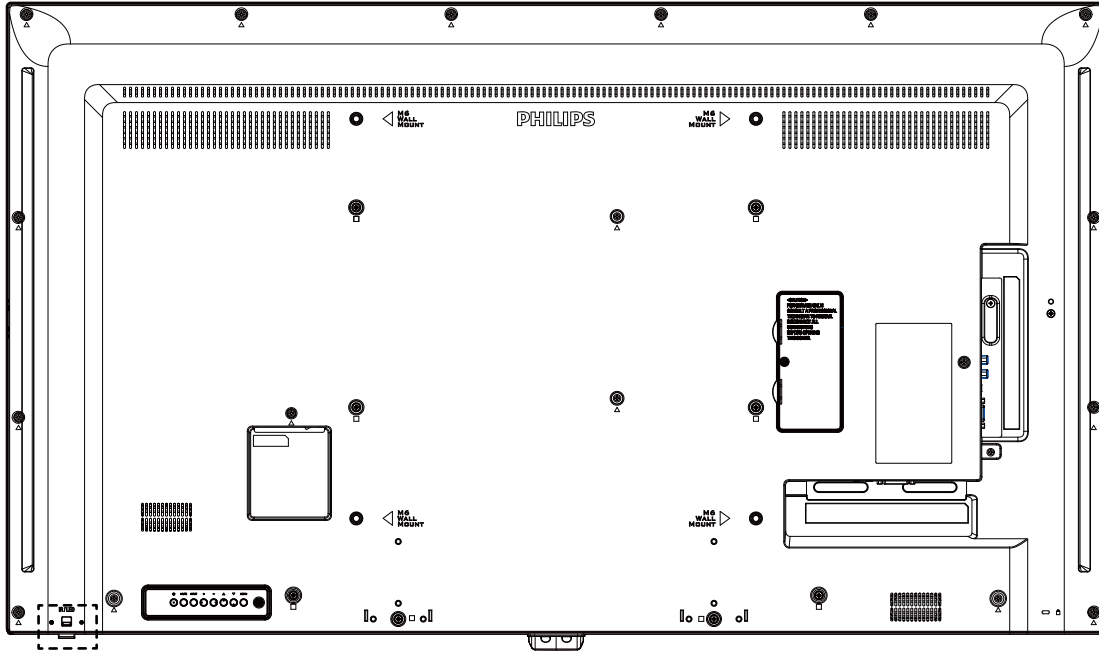



## 2.4. USB Cover

- Use the USB cover and screws to hide the USB stick and Micro SD card.

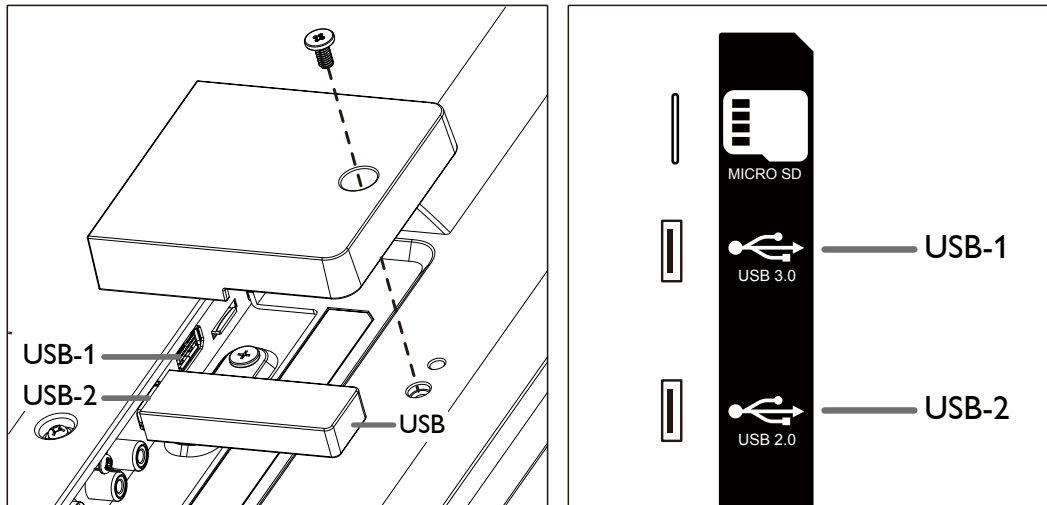

- Maximum suitable USB sticker size:  
USB-1: 20(W)×10(H)×60(L) mm  
USB-2: 20(W)×10(H)×60(L) mm

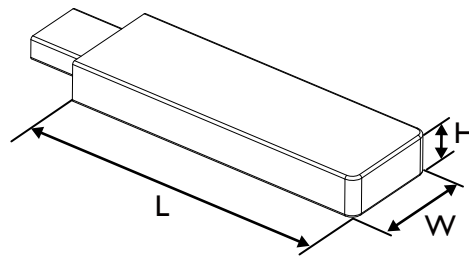

## 2.5. Remote Control

### 2.5.1. General functions

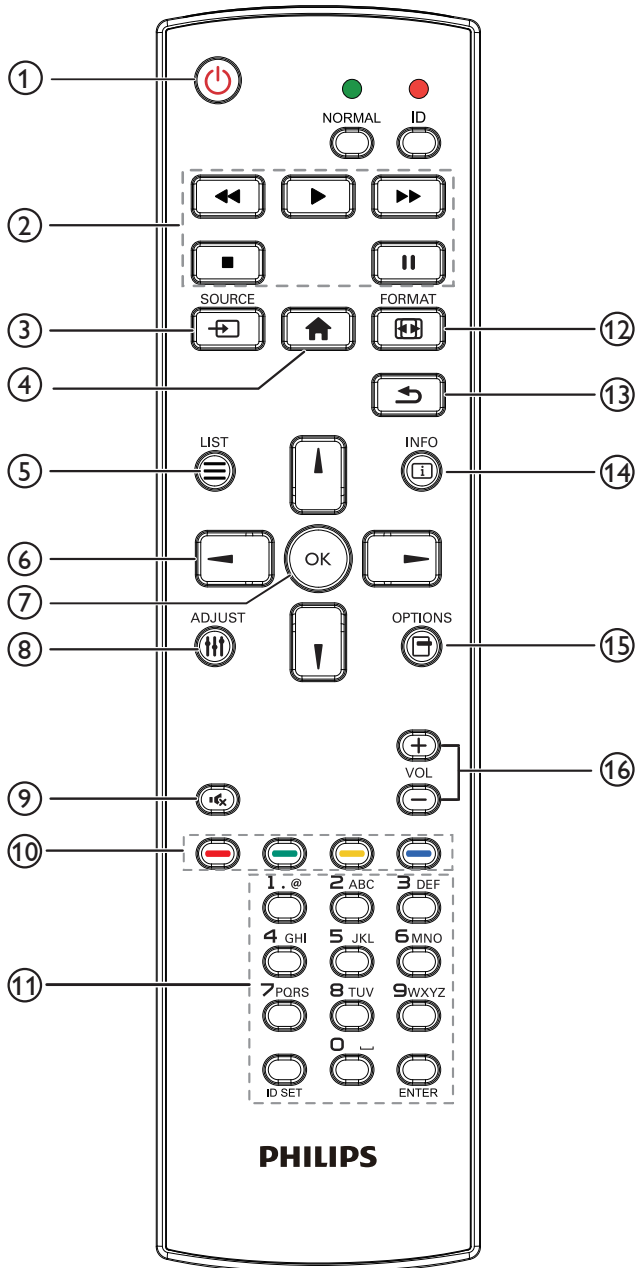

① **[POWER] POWER button**

Power ON/OFF.

② **[PLAY] buttons**

Control playback of media files.(for Media Input only)

**Freeze feature**

**Pause:** Freeze hot key for all inputs content.

**Play:** Unfreeze hot key for all input content.

③ **[SOURCE] SOURCE button**

Root Menu: Go to Video source OSD.

④ **[HOME] HOME button**

Root Menu: Go to Main Menu OSD.

Others: Exit OSD.

⑤ **[LIST] LIST button**

No function.

⑥ **NAVIGATION buttons**



**Root Menu:** Go to Smart picture OSD.

**Main Menu:** Move the highlight bar up to adjust the selected item.

**IR Daisy Chain Menu:** Increase controlled Group ID number.



**Root Menu:** Go to Audio source OSD.

**Main Menu:** Move the highlight bar down to adjust the selected item.

**IR Daisy Chain Menu:** Decrease controlled Group ID number.



**Main Menu:** go to previous level menu.

**Source Menu:** Exit source menu.

**Volume Menu:** Decrease Audio Volume.



**Main Menu:** go to next level menu or set selected option.

**Source Menu:** Go to selected source.

**Volume Menu:** Increase Audio Volume.

⑦ **[OK] button**

Root Menu: Go to IR daisy chain OSD in Primary/Secondary mode.

Main Menu: Confirm an entry or selection.

⑧ **[ADJUST] ADJUST button**

Go to Auto Adjust OSD for VGA only.

⑨ **[MUTE] MUTE button**

Toggle Audio Mute/Unmute.

⑩ **[COLOR] COLOR buttons**

Choose tasks or options.(for Media Input only)

[Hot key] Hot key for Window selection function.

⑪ **[Number/ ID SET/ ENTER] button**

Enter text for network setting.

Press to set the display ID. Refer to **2.5.2. ID Remote Control** for more detail.

⑫ **[FORMAT] FORMAT button**

Change Image Zoom Mode [Full][4:3][1:1][16:9][21:9][Custom].

⑬ **[BACK] BACK button**

Return to the previous menu page or exit from the previous function.

⑭ **[INFO] INFO button**

Show Information OSD

⑮ **[OPTIONS] OPTIONS button**

No function.

⑯ **[VOLUME] VOLUME button**

Adjust volume.

## 2.5.2. ID Remote Control

You can set the remote control ID when you want to use this remote control on one of several different displays.

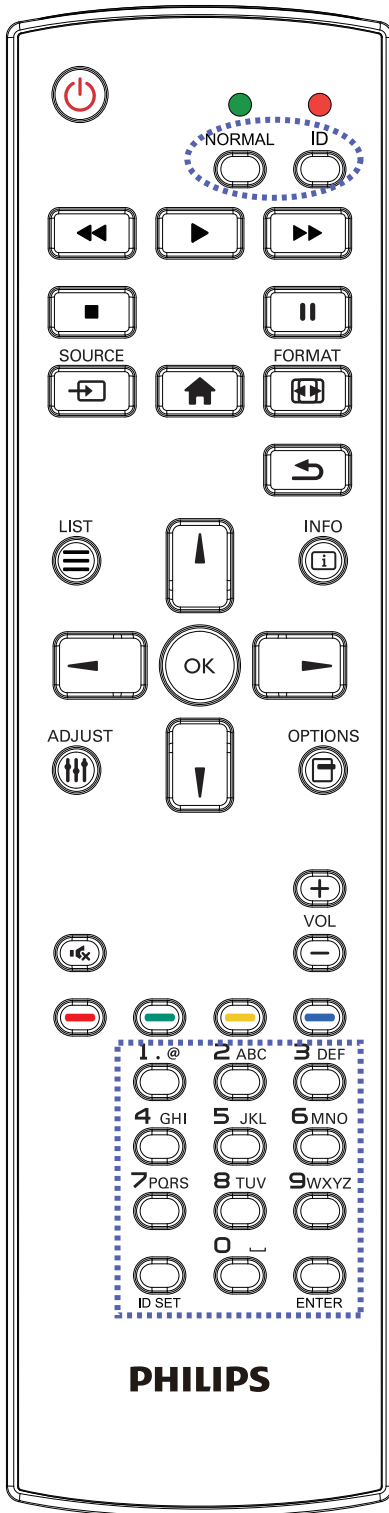

Press [ID] button. The red LED blinks twice.

1. Press [ID SET] button for more than 1 second to enter the ID Mode. The red LED lights up. Press the [ID SET] button again will exit the ID Mode. The red LED lights off.

Press the digit numbers [0] ~ [9] to select the display you want to control.

For example: press [0] and [1] for display No.1, press [1] and [1] for display No.11.

The numbers available are from [01] ~ [255].

2. Not pressing any button within 10 seconds will exit the ID Mode.
3. If an error pressing of buttons other than the digits occurred, wait 1 second after the red LED lights off and then lights up again, then press the correct digits again.
4. Press [ENTER] button to confirm. The red LED blinks twice and then lights off.

### NOTE:

- Press [NORMAL] button. The green LED blinks twice, indicating the display is in normal operation.
- It is necessary to set up the ID number for each display before selecting its ID number.

### 2.5.3. Remote Control buttons on Android source

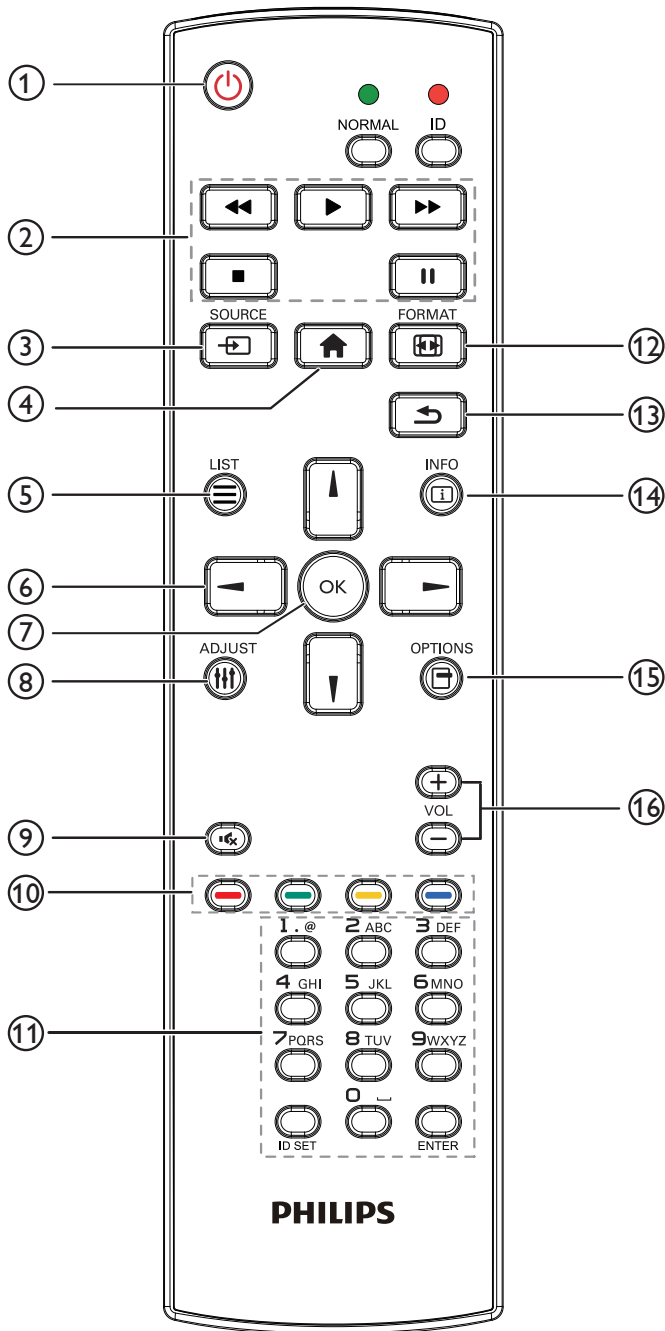

#### ① [POWER] POWER button

Turn the display on or put the display to standby.  
The button is only controlled by Scalar.

#### ② [PLAY] buttons

1. Control playback of media(video/audio/picture) files.  
There are 4 ways to play media files.

1) File Manager

Find the media file from the File Manager and select it to play.  
2) Media Player -> Compose -> edit or new add playlist -> choose any media files -> press to play the media file directly.

3)Media Player -> Play -> choose non-empty play list -> press to play all the media files in the play list.

4) Set media playlist in Boot on Source or Schedule by OSD menu.

2. Play PDF file

There are 3 ways to play media files.

1) File Manager

Find the pdf file from the File Manager and select it to play.

2) PDF Player -> Play -> choose non-empty play list -> press to play all the PDF files in the play list.

3) Set pdf playlist in Boot on Source or Schedule by OSD menu.

3. When playing PDF, video or music, press to stop playing.  
Then if pressing again, playing will be started from the beginning of the file.

4. When playing PDF, video or music, press button to pause playing.

5. All media or pdf files should be put at the folder, which is named "philips" with sub-folder, under the root directory of the specified storage (internal/USB/SD Card). All sub-folders (video/photo/music/pdf) are named by media types and shouldn't be changed.

**videos:** {root dir of storage}/philips/video/  
**photos:** {root dir of storage}/philips/photo/  
**music :** {root dir of storage}/philips/music/  
**pdfs :** {root dir of storage}/philips/pdf/

Note that the root directories of three storages are

**Internal storage:** /sdcard

**USB storage:** /mnt/usb\_storage

**SD card :** /mnt/external\_sd

#### ③ [SOURCE] SOURCE button

Choose input source.

The button is only controlled by Scalar.

#### ④ [HOME] HOME button

Access OSD menu.





The button is only controlled by Scalar.

#### ⑤ [LIST] LIST button

1. In the content of the web page, move the focus up to the next clickable items.

2. Move the focus up to the next control or widget such as buttons.

## ⑥ NAVIGATION buttons

1. Navigate through menus and choose items.
2. In the content of the web page, these buttons are to control the scroll bar of the screen. Press  or  is for moving vertical scroll bar up or down. Press  or  is for moving horizontal scroll bar left or right.

3. For PDF files,  
» when zoom in/out has been performed,

Press , ,  or  to adjust the position of the screen.

» when zoom in/out has been not performed,

Press  to go to the next page.

Press  to go to the previous page.

## ⑦ [OK] button

Confirm an entry or selection.

## ⑧ [||||] ADJUST button

1. In the content of the web page, move the focus down to the next clickable items.
2. Move the focus down to the next control or widget such as buttons.

## ⑨ [M] MUTE button

Press to turn the mute function on/off.  
The button is only controlled by Scalar.

## ⑩ [Red] [Green] [Yellow] [Blue] COLOR buttons

1.  : No function on Android source. These two buttons are only controlled by Scalar.



2. For PDF files,

press  button to perform zoom-in;

press  button to perform zoom-out.

After zoom-in or zoom-out, press  button to revert the pdf file to the original size.

## ⑪ [Number/ ID SET/ ENTER] button

1. No functions for ID SET  and ENTER  on Android source. These buttons are only controlled by Scalar.
2. For PDF file, enter the page number by pressing number buttons and then press  button to jump to the specific page.

## ⑫ [FORMAT] FORMAT button

Change picture format. The button is only controlled by Scalar.

## ⑬ [BACK] BACK button

Return to the previous page or exit from the previous function.

## ⑭ [i] INFO button

1. Display information about current input signal. It is shown by Scalar.

2. Media Player -> Compose -> edit or new add playlist -> choose any media files -> press  to show the information of the chosen media file.

## ⑮ [OPTIONS] OPTIONS button

Open toolbox in Media Player or PDF Player:

1. Media Player -> Compose -> Edit or new add playlist -> press  to open toolbox. Toolbox will be slide from the left side of the screen.

2. PDF Player -> Compose -> Edit or new add playlist -> press  to open toolbox. Toolbox will be slide from the left side of the screen.

## ⑯ [VOLUME] VOLUME button

Adjust volume. The buttons are only controlled by Scalar.

### 3. Connecting External Equipment

#### 3.1. Connecting External Equipment (DVD/VCR/VCD)

##### 3.1.1. Using HDMI video input

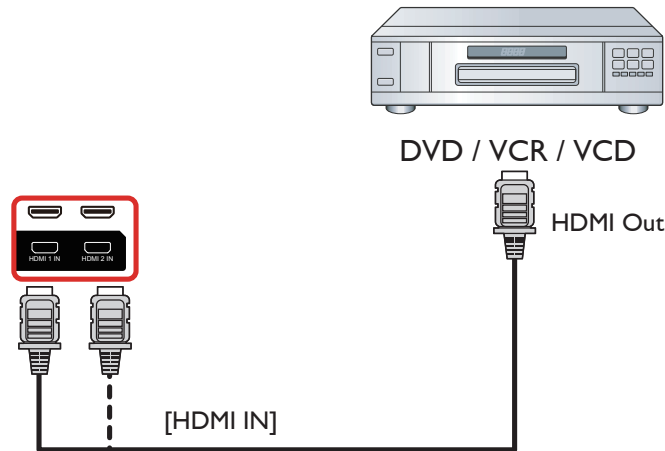

#### 3.2. Connecting a PC

##### 3.2.1. Using VGA input

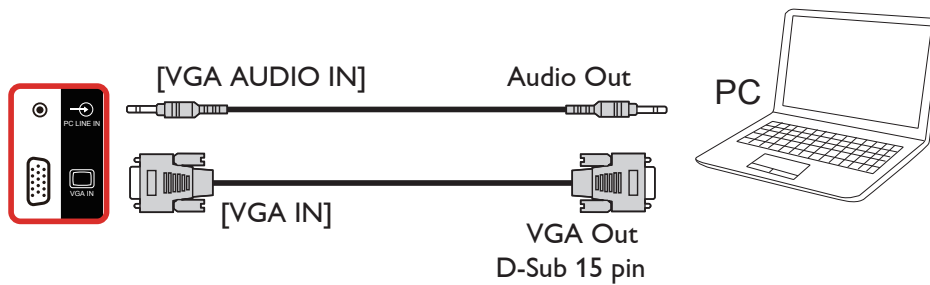

##### 3.2.2. Using DVI input

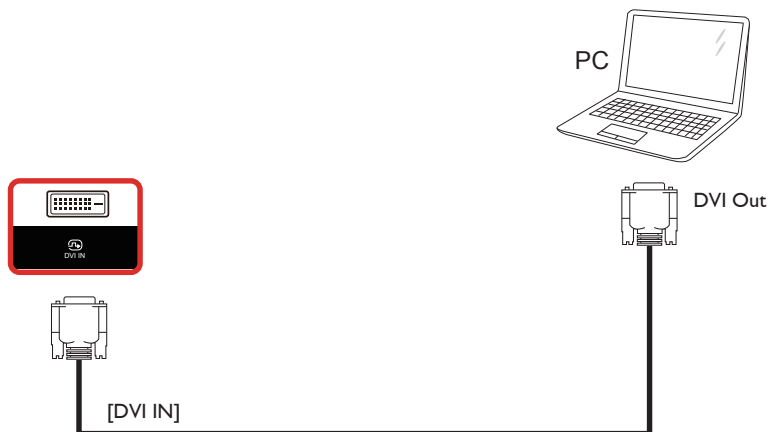



### 3.2.3. Using HDMI input

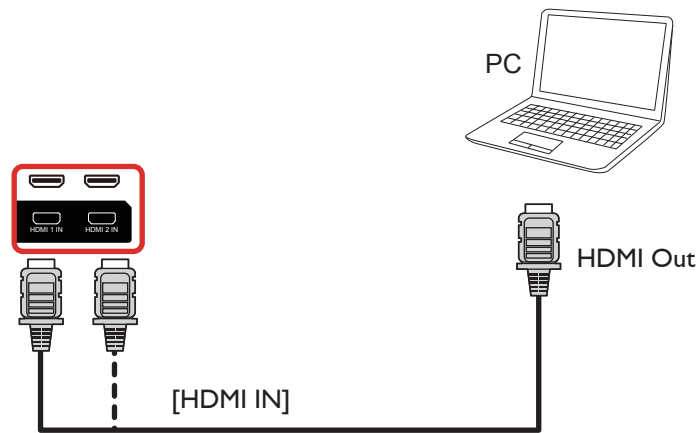

## 3.3. Connecting Audio Equipment

### 3.3.1. Connecting an external audio device

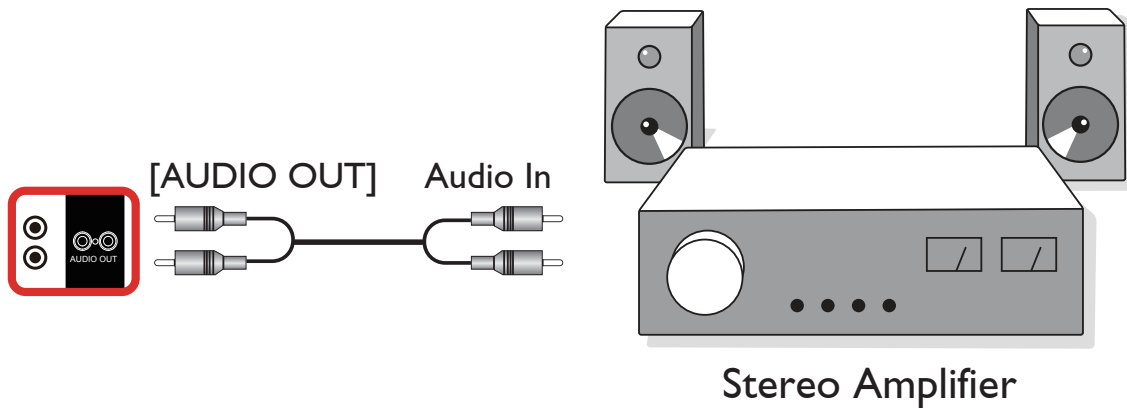

## 3.4. Connecting Multiple Displays in a Daisy-chain Configuration

You can interconnect multiple displays to create a daisy-chain configuration for applications such as a menu board.

### 3.4.1. Display control connection

Connect the [RS232 OUT] connector of DISPLAY 1 to the [RS232 IN] connector of DISPLAY 2.

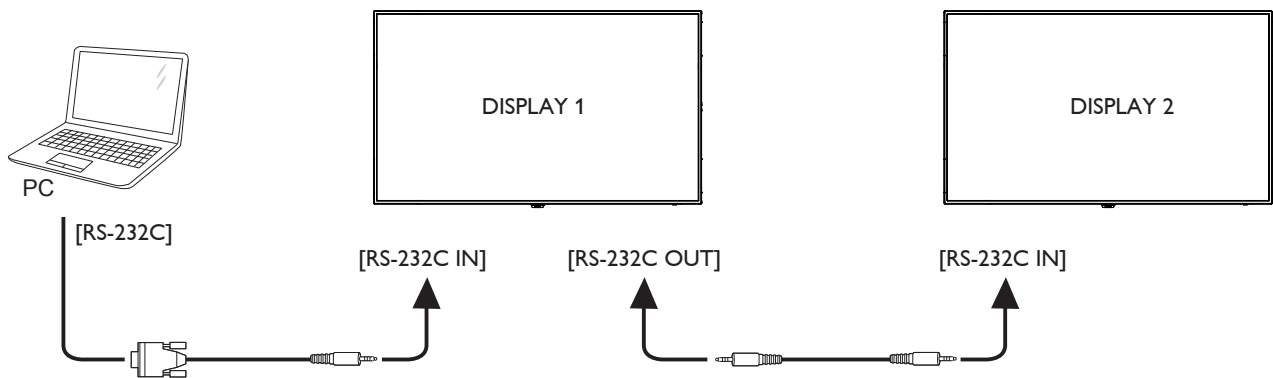

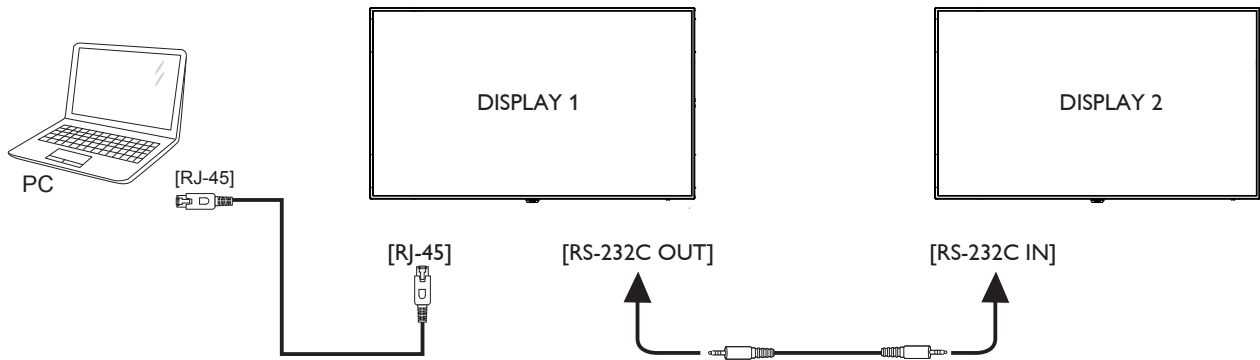

### 3.5. IR connection

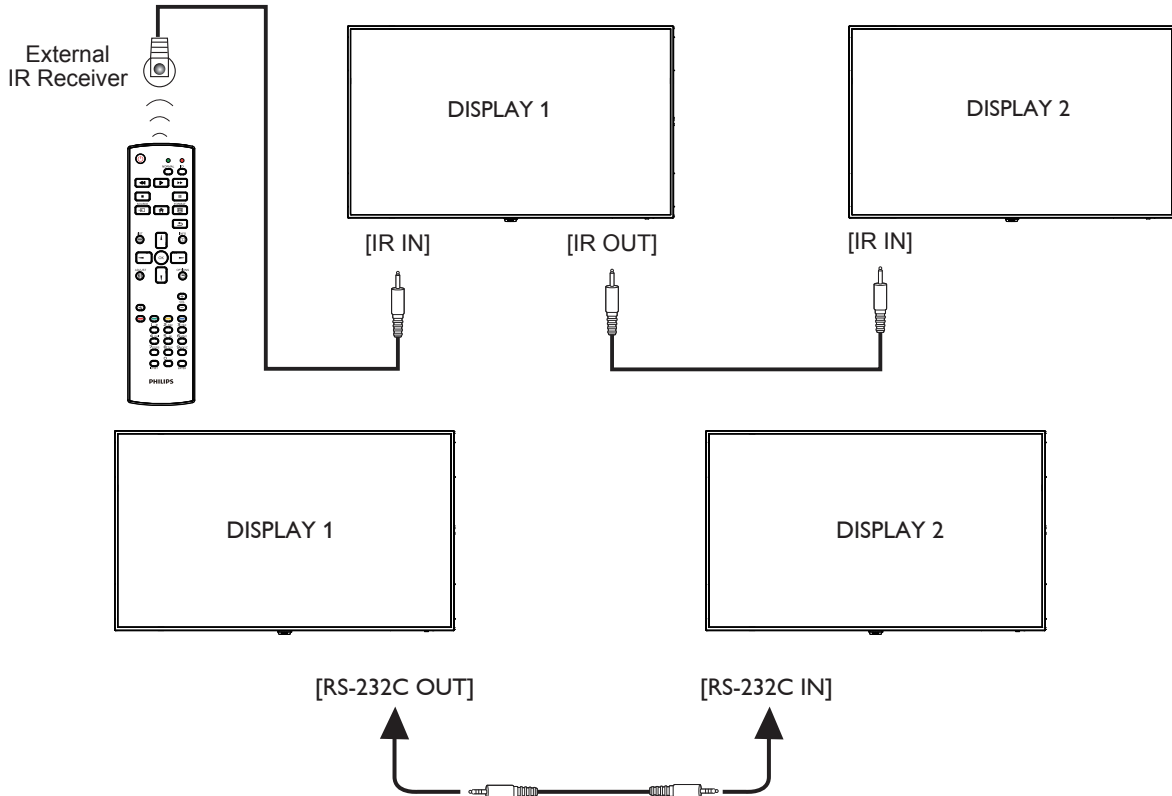

**NOTE:**

1. This display's remote control sensor will stop working if the [IR IN] is connected.
2. IR loop through connection can support up to 9 displays.
3. IR in daisy chain via RS232 connection can support up to 9 displays.

### 3.6. IR Pass-through Connection

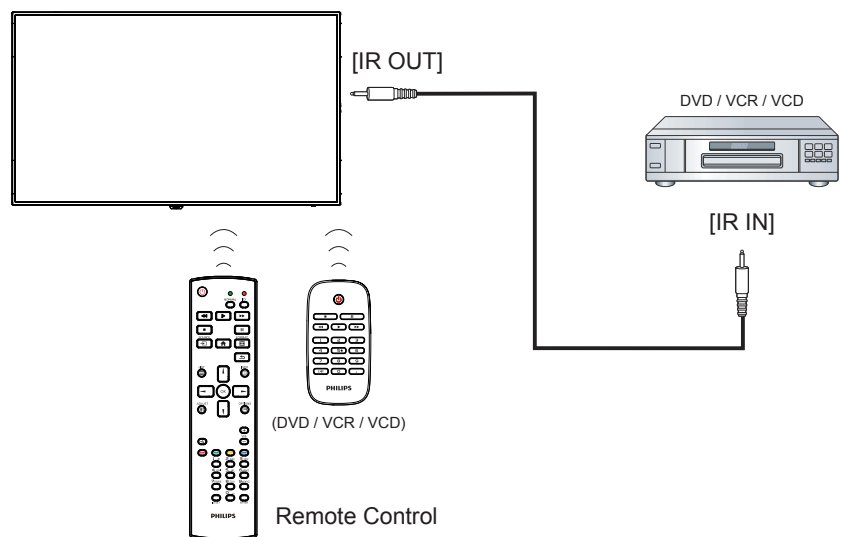

## 4. Operation

**NOTE:** The control button described in this section is mainly on the remote control unless specified otherwise.

### 4.1. Watch the Connected Video Source

1. Press **[↔]** SOURCE button.
2. Press **[M]** or **[T]** button to choose a device, then press **[OK]** button.

### 4.2. Change Picture Format

You can change the picture format to suit the video source. Each video source has its available picture formats.

The available picture formats depend on the video source:

1. Press **[F]** FORMAT button to choose a picture format.
  - PC mode: {Full} / {4:3} / {Real} / {21:9} / {Custom}.
  - Video mode: {Full} / {4:3} / {Real} / {21:9} / {Custom}.

### 4.3. Overview

1. Android PD launcher:
  - Android PD launcher is black page, as below:

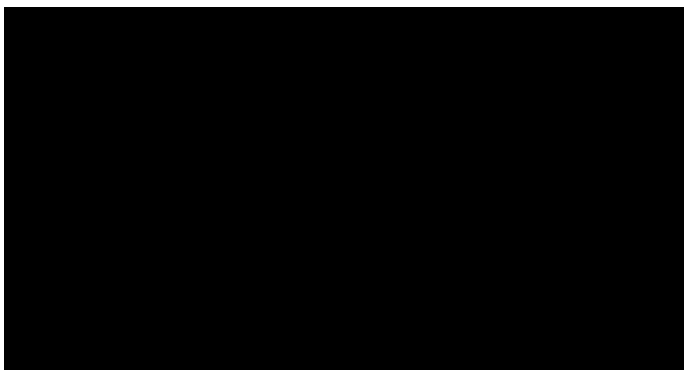

- Every apps leave by press back key, the screen will go to android PD launcher.
- When you return to android PD launcher; the screen will show hint image, the hint image only show 5 second, as below:
- The hint image will notify you can press source key to change source.

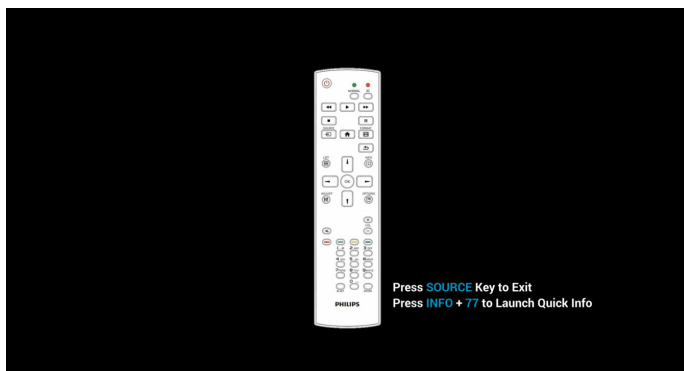

2. Admin mode:
  - You can press "Home + 1888" to enter admin mode. Please make sure you see the Home OSD menu after "Home" is pressed, and then press 1888 in sequence. Two continuous "Home" keys will not be a valid hotkey.

- Admin mode will show five icons: "Settings", "Apps", "Network", "Storage" and "Help".
- When you leave admin mode, system will return to last source.

1) Home page of admin mode, this page has five items: "Settings", "Apps", "Network", "Storage" and "Help".

Settings : go to settings app.

Applications : show all apps.

Network : set Wi-Fi (optional), Ethernet

Storage : display current PD Android storage information.

Help : display QRcode.

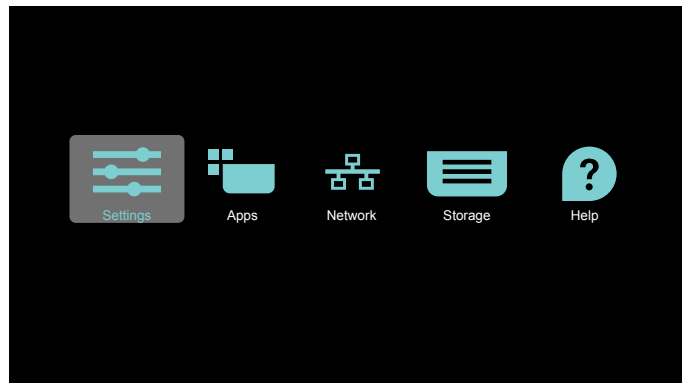

2.) Application page:

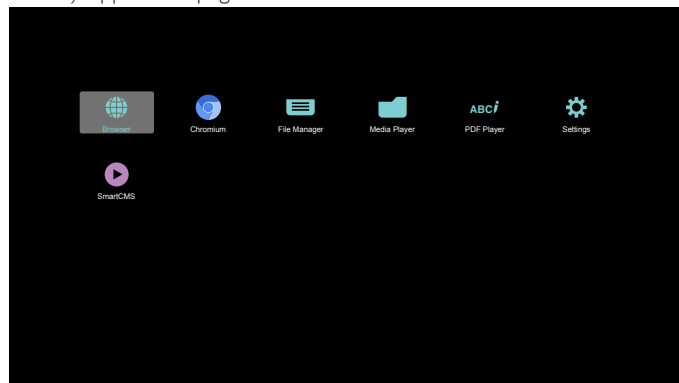

3) Network page

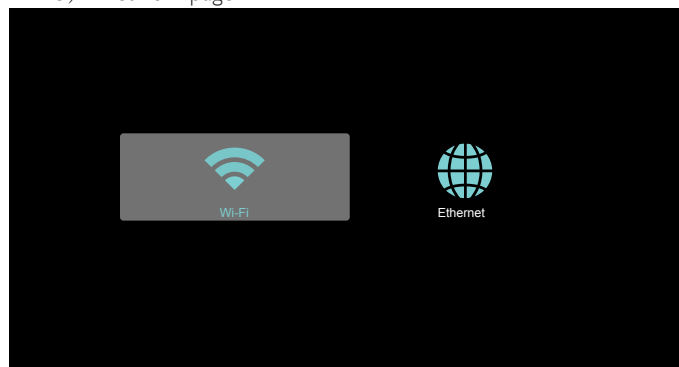

#### 4) Ethernet page

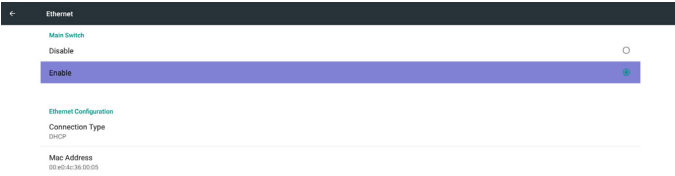

#### 5) Wi-Fi (Optional)



#### 6) Help page:

Display QRcode page.



### 4.4. Media Player introduction:

- Home page of Media Player, this page has three items: "Play", "Compose" and "Settings".  
 Play : select playlist to play.  
 Compose: edit playlist.  
 Settings: setting play properties.

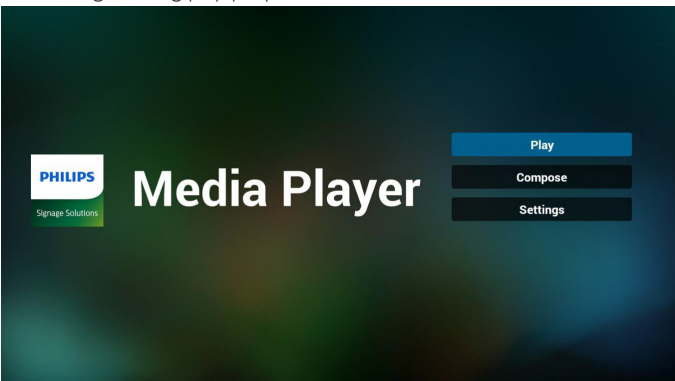

- Select "Play" on home page, first you should choose one playlist to play between FILE 1 and FILE 7.  
 The pencil icon means the playlist is non-empty.

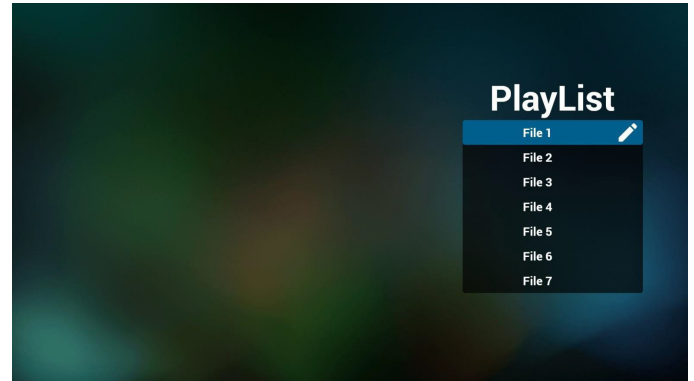

- Select "Compose" on home page, first you should choose one playlist to edit between FILE 1 and FILE 7.  
 The pencil icon means the playlist is non-empty.

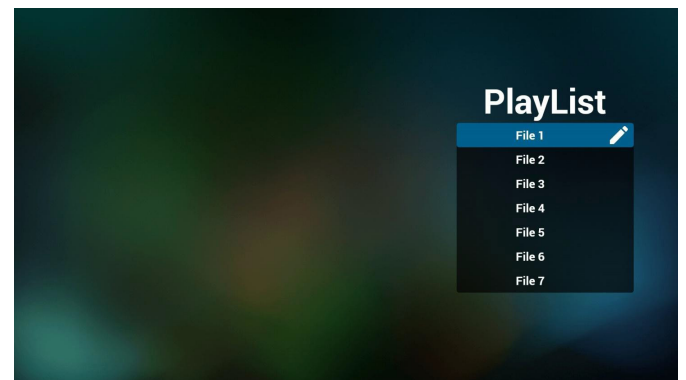

- If an empty playlist is chosen, the app will guide you to select the media source.  
 All media files should be placed in /philips/ of root directory.  
 For example,  
**videos: {root dir of storage}/philips/video/**  
**photos: {root dir of storage}/philips/photo/**  
**music : {root dir of storage}/philips/music/**

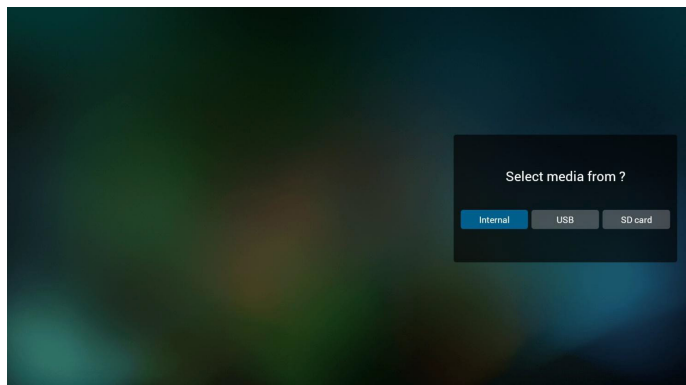

- You could edit or delete a non-empty playlist, just choose the desired playlist which is with pencil icon.

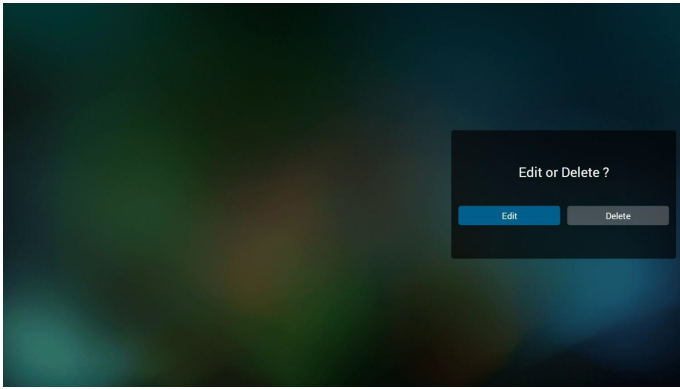

- Press info key after you choose desired file, you will get the detail information.

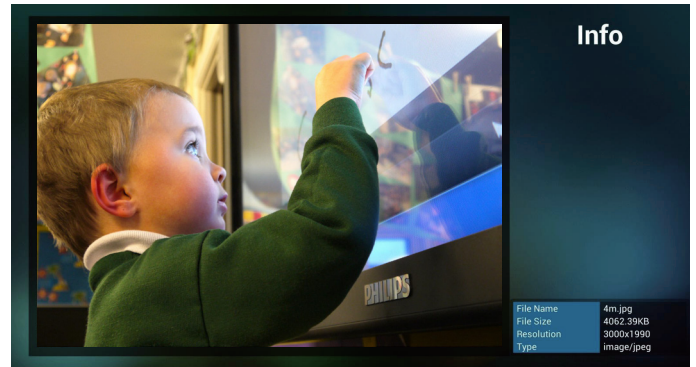

- Once you start to edit a playlist, you will see below screen.  
 Source - files in storage.  
 Playlist - files in playlist.  
 There are 4 icons which map to the keys of remote controller:  
 Option key - launch slide bar  
 Play key - play media file.  
 Info key - show media info.  
 Ok key - select/unselect file.

6-1 In the slide bar, it helps you to do the following:

- select all : select all storage files.
- delete all : delete all playlist files.
- add/remove : update playlist from source.
- sort : sort playlist.
- save/abort : save or abort playlist.
- back : return.

- Press play key after you choose desired file, you will play the media file directly.

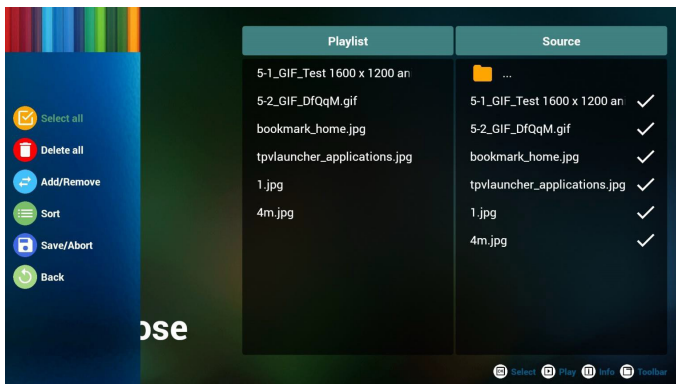

- If you make a playlist with all images files, before saving, the app will ask you if you want to have background music while playing slideshow.

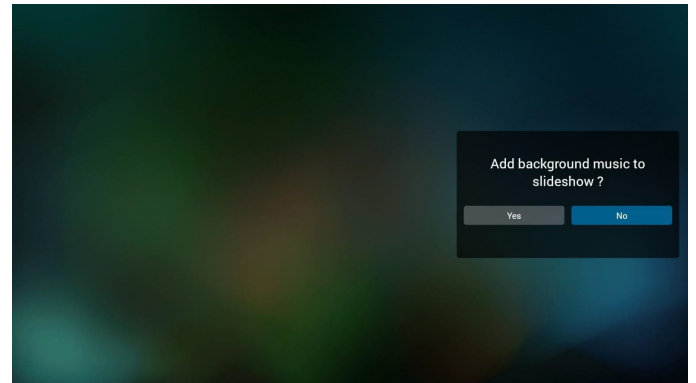

- If you choose "Sort" in the slide bar, you can change the order of files one by one.

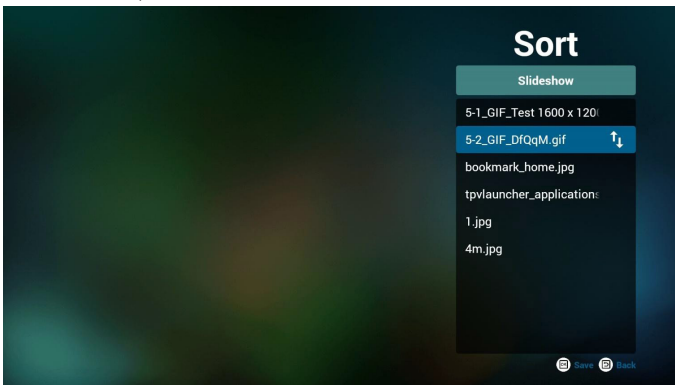

- Select "Settings" on home page, this page has three parts, "Repeat Mode", "Slideshow Effect" and "Effect Duration".

Repeat Mode : play mode.  
 Slideshow Effect : photo slideshow effect.  
 Effect Duration : photo effect duration.

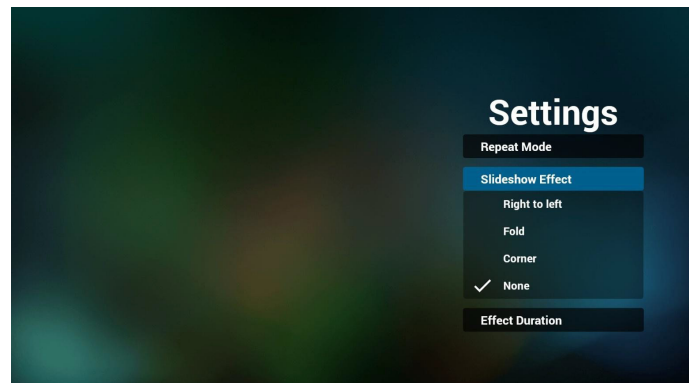



12. Media Hotkey
  - Play : Playback file.
  - Pause: Pause file.
  - Fast forward: forward 10 second.
  - Rewind: back 10 second.
  - Stop: Stop file and return to start. If the gif file, it like the pause.

13. Media format please refer to **Supported Media Formats**.

14. How to edit playlist via FTP.

Step 1. Create media player text file.

- File name : mpplaylistX.txt, "X" means playlist number(1,2,3,4,5,6,7).

Ex. mpplaylist1.txt, mpplaylist2.txt

- Content :

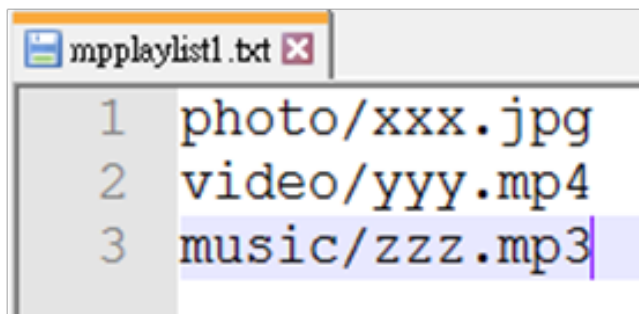

Note : if playlist file contains video and music, when the pd plays music file, the screen will be black.

Step 2. Copy mpplaylistX.txt to "philips" folder of internal storage. You may use FTP to do this.

- File path : /storage/emulated/legacy/philips

Ex. /storage/emulated/legacy/philips/mpplaylist1.txt

Step 3. Prepare media files to "photo", "video" and "music" folder under "philips" folder; internal storage only.

- Ex. /storage/emulated/legacy/philips/photo/xxx.jpg

/storage/emulated/legacy/philips/video/yyy.mp4

/storage/emulated/legacy/philips/photo/zzz.mp3

Step 4. Start media player app, it will auto import media player text file.

PS. Once the playlist file (text) is imported, if an user change playlist by remote controller; this change will not be written to playlist text file.

## 4.5. Browser manual

1. Home page of Browser app, this page has one item: "Settings". Press Settings then enter next page.

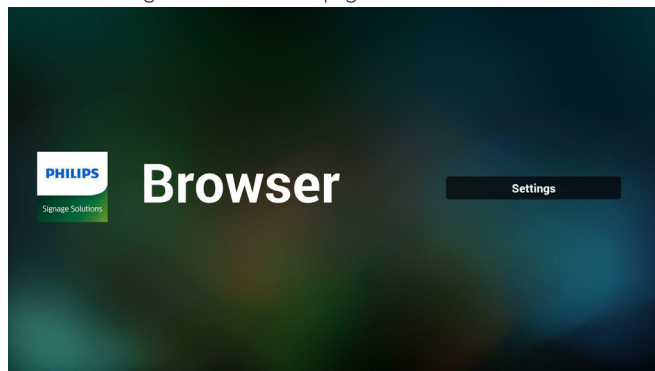

2. Users can choose 1~7. Press any one will show a dialog.

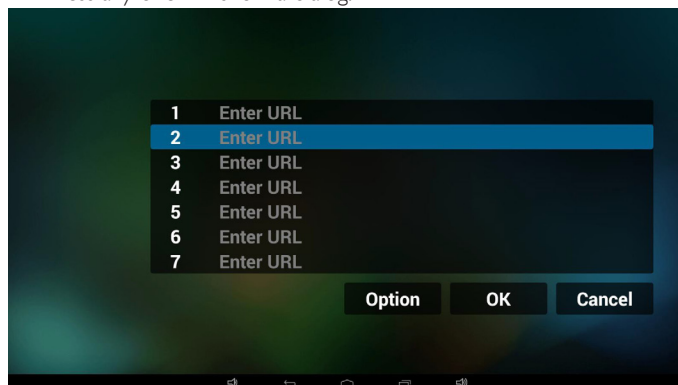

3. Enter url and press OK then data will save on List

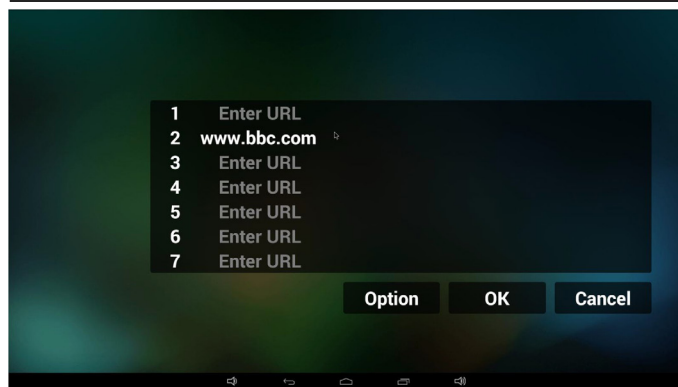
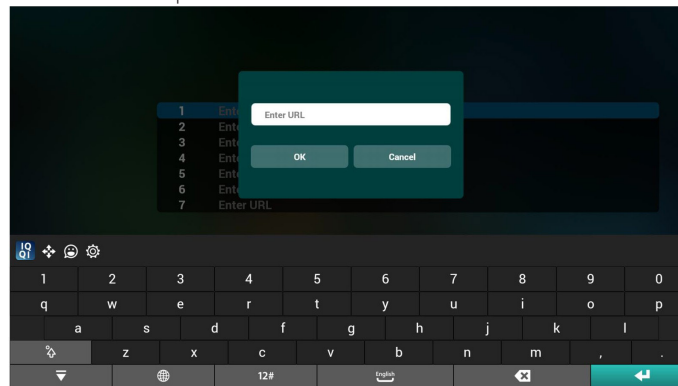

- Press "Option" then left side will pop up a list  
 Import : Import url list file  
 Export : Export url list file  
 Delete all : Delete all url record on right side  
 Back : left side list will be closed.

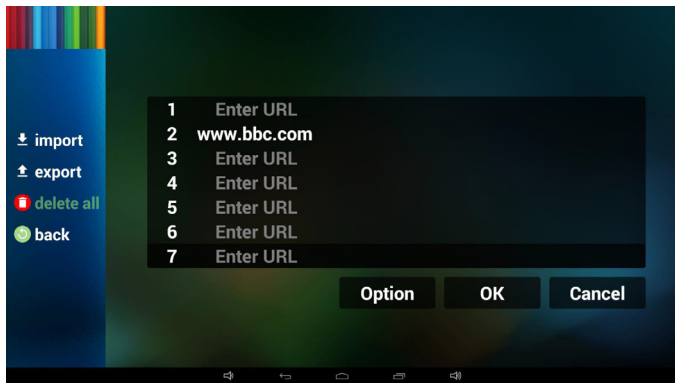

#### 4.1 Import

- Click import

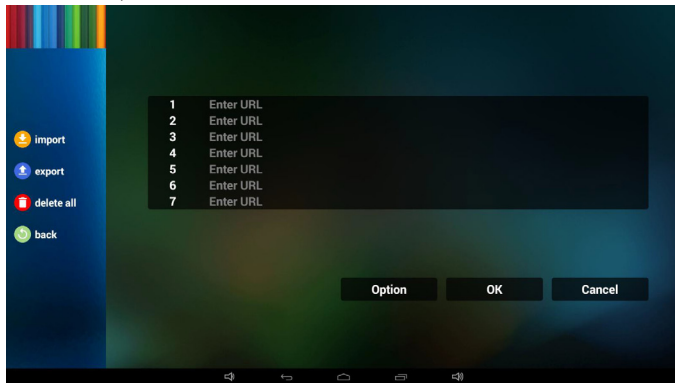

- Choose storage

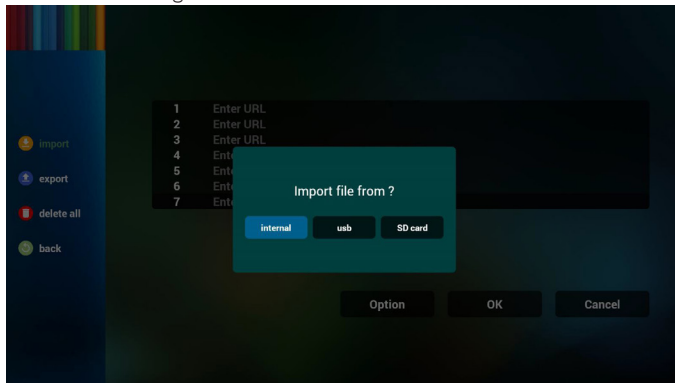

- Choose file contains urls

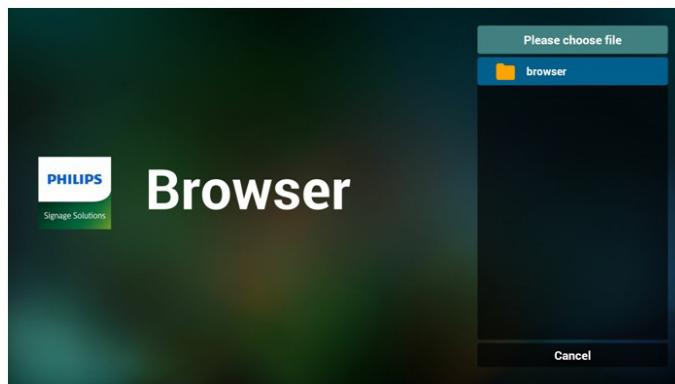

- Import file and url will show on list

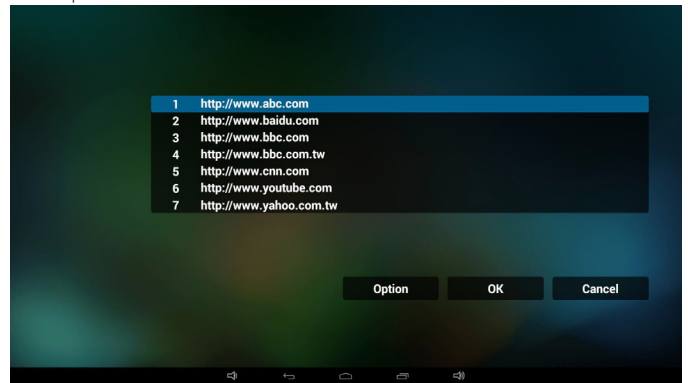

- File format for import  
 Format should be like below with file extension "txt"

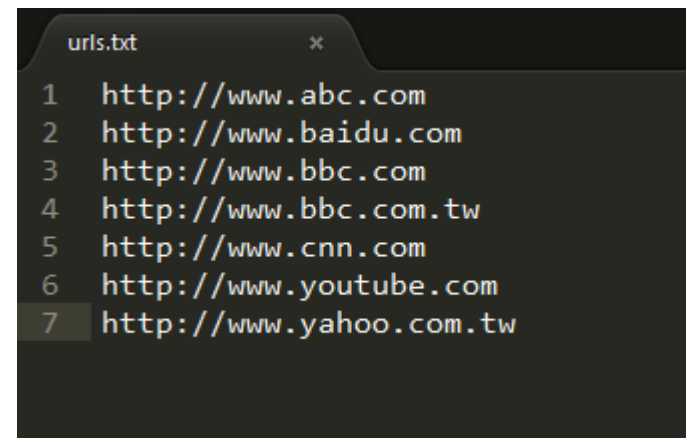

#### 4.2 Export

- Click export

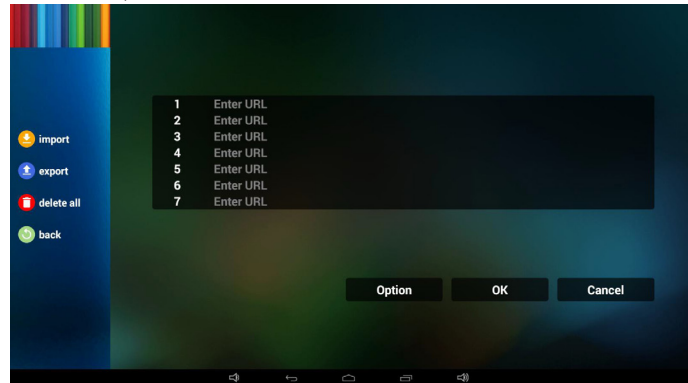

- Choose storage

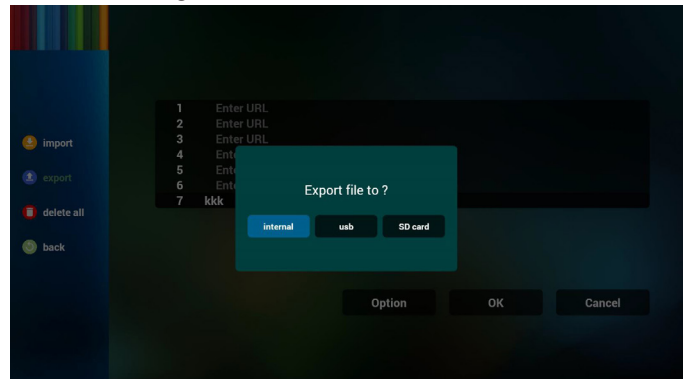

- Dialog shows path file will be saved and file's name. Press "save" button then urls on list will be saved.

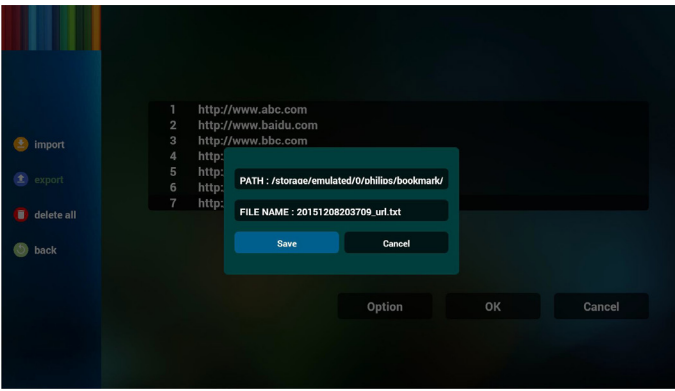

5. Press OK then url records will be saved

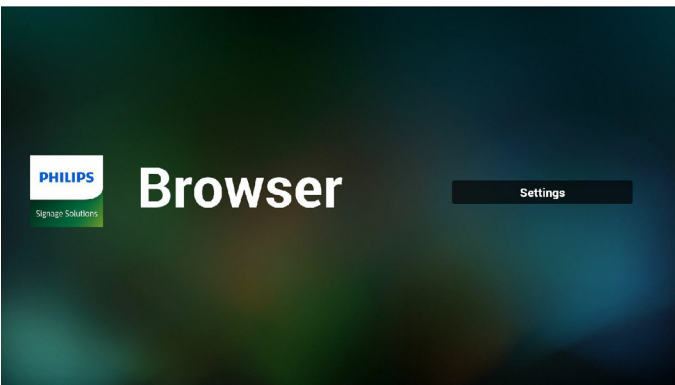
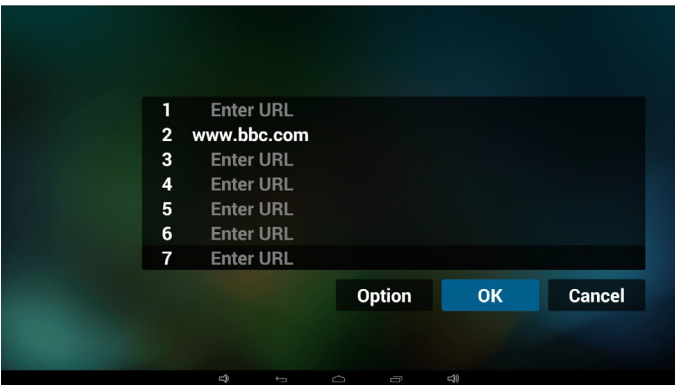

6. On url list page, if you select non-empty item, it will show a dialog to ask edit or play url. If press "Edit", it will show edit url dialog, if press "Play", it will show web page of item's url.

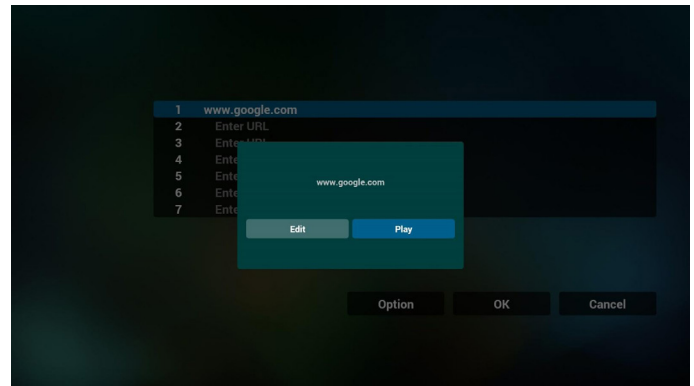
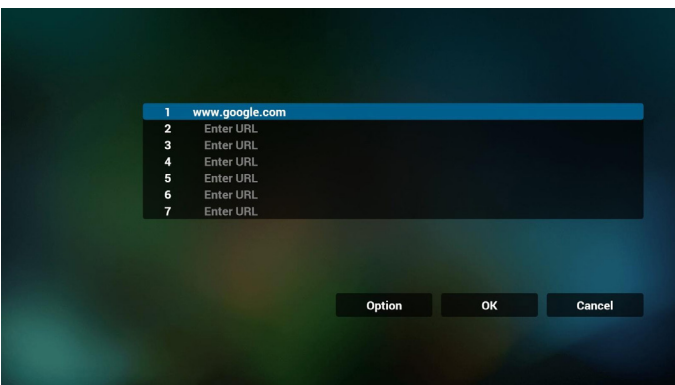

7. OSD menu interaction with Browser

### 7.1 Boot on source

- Set OSD menu => Configuration1 => Boot on source => Input be BROWER Play List be 0. Then PD will show Browser after reboot.
- Set OSD menu => Configuration1 => Boot on source => Input be BROWER Play List be 1. Then PD will show web page with 1st Url in Browser app.

### 7.2 Schedule

Set OSD menu => Advanced option => Schedule =>

On time1, Off time2, Input be BROWSER, any day you want of week, and Play List.

Finally check the right box.

Then PD will show web page with Url in Browser app at time1 and finish at time2.

8. How to edit url list via FTP

Step 1. Create media player text file.

- File name : bookmarklist.txt.
- Content :



Step 2. Copy bookmarklist.txt to "philips" folder of internal storage. You may use FTP to do this.

- File path : /storage/emulated/legacy/philips (for DL, PL)  
Ex. /storage/emulated/legacy/philips/bookmarklist.txt

Step 3. Start browser app, it will auto import browser text file.

PS. Once the playlist file (text) is imported, if an user change playlist by remote controller, this change will not be written to playlist text file.

## 4.6. PDF reader play

1. Home page of PDF Player; this page has three items: "Play", "Compose" and "Settings".  
 Play : select playlist to play.  
 Compose: edit playlist.  
 Settings: setting play properties.

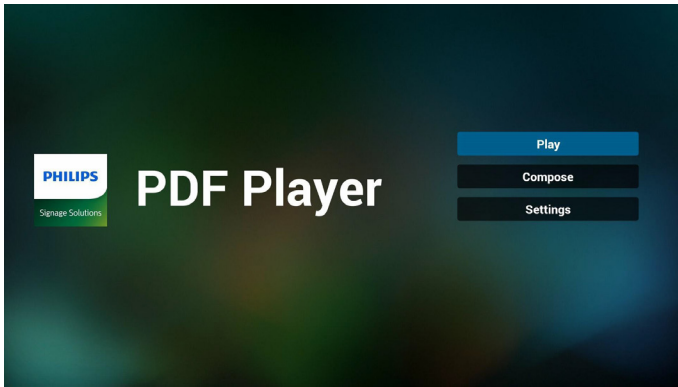

2. Select "Play" on home page, first you should choose one playlist to play between FILE 1 and FILE 7.  
 The pencil icon means the playlist is non-empty.

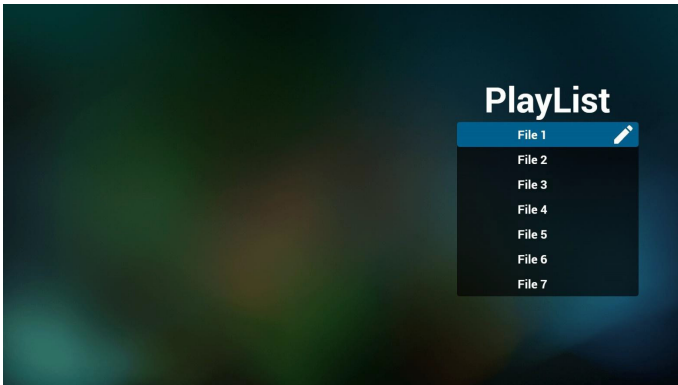

3. Select "Compose" on home page, first you should choose one playlist to edit between FILE 1 and FILE 7.  
 The pencil icon means the playlist is non-empty.

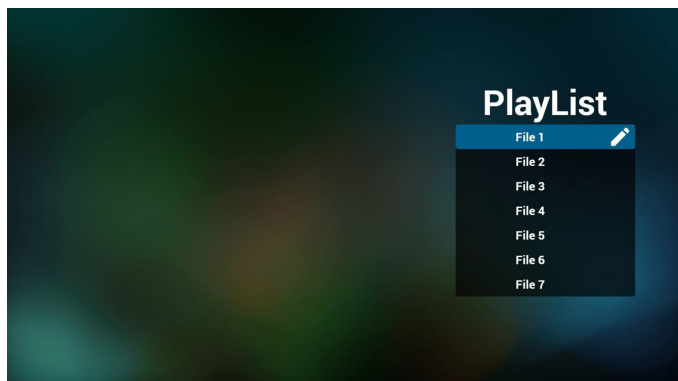

4. If an empty playlist is chosen, the app will guide you to select the media source.  
 All media files should be placed in /philips/ of root directory. For example,  
**pdfs : {root dir of storage}/philips/pdf/**

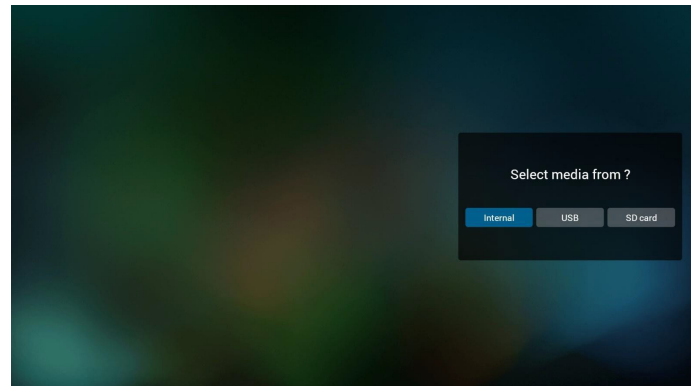

5. You could edit or delete a non-empty playlist, just choose the desired playlist which is with pencil icon.

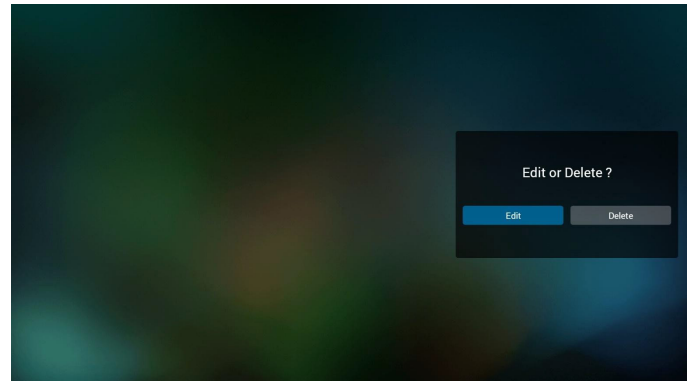

6. Once you start to edit a playlist, you will see below screen.  
 Source - files in storage.  
 Playlist – files in playlist.  
 There are 4 icons which map to the keys of remote controller:  
 Option key – launch slide bar  
 Play key – play media file.  
 Info key – show media info.  
 Ok key – select/unselect file.  
 6-1. In the slide bar, it helps you to do the following:  
 - select all : select all storage files.  
 - delete all : delete all playlist files.  
 - add/remove : update playlist from source.  
 - sort : sort playlist.  
 - save/abort : save or abort playlist.  
 - back : return.

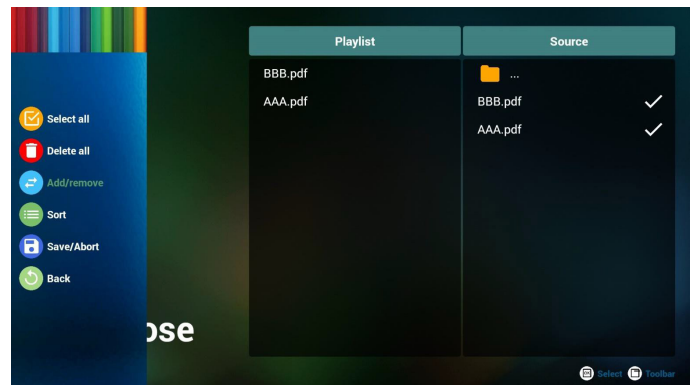



7. If you choose "Sort" in the slide bar, you can change the order of files one by one.

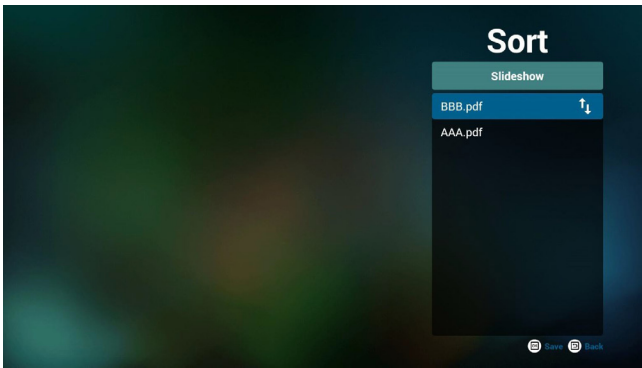

8. Select "Settings" on home page, this page has two parts, "Repeat Mode" and "Effect Duration".

Repeat Mode : play mode.

Effect Duration : photo effect duration.

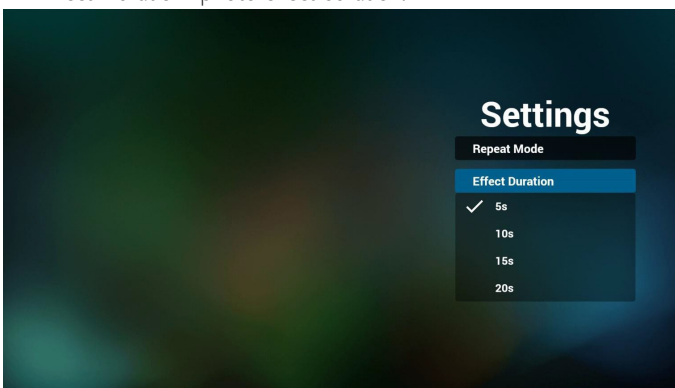

9. How to edit pdf list via FTP.  
Step 1. Create pdf player text file.

- File name : pdfplaylistX.txt, "X" means playlist number(1,2,3,4,5,6,7).  
Ex. pdfplaylist1.txt, pdfplaylist2.txt
- Content :

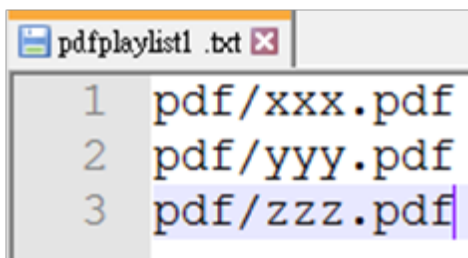

Step 2. Copy pdfplaylistX.txt to "philips" folder of internal storage. You may use FTP to do this.

- File path : /storage/emulated/legacy/philips (for DL, PL)  
Ex. /storage/emulated/legacy/philips/pdfplaylist1.txt

Step 3. Prepare pdf files to "pdf" folder under "philips" folder, internal storage only.

- Ex. /storage/emulated/legacy/philips/pdf/xxx.pdf  
/storage/emulated/legacy/philips/pdf/yyy.pdf  
/storage/emulated/legacy/philips/pdf/zzz.pdf

Step 4. Start pdf player app, it will auto import pdf player text file.  
PS. Once the playlist file (text) is imported, if an user change playlist by remote controller; this change will not be written to playlist text file.

### Media Hotkey:

Play : Playback file.

Pause: Pause page.

Fast forward: go to next page, if the page is end of the file, it will go to next file.

Rewind: back to last page, if the page is first of the file, it will back to last file.

Stop: return to first page of file

### Color Hotkey:

Blue : Zoom in.(+10%)

Yellow : Zoom out.(-10%)

OK : Restore zoom

### Arrow keys:

Up/Down/Left/Right : Adjust page. (When the page has zoomed in/out)

Left : Previous Page. (When the page has not zoomed in/out)

Right : Next Page. (When the page has not zoomed in/out)

### Combination key:

Number key + OK key : select specific page, and press ok key to change page.

- Press number key.

- Press OK key, the bottom of the page will show the page number; if page number over total page number; it will not change page and show current page number at the bottom of the page.

## 4.7. CMND & Play

1) Server

Setup CMND & Play server address

2) Account

Setup CMND & Play account

3) PIN Code

Setup CMND & Play PIN code

(4) Version

There are two options, Ver:2 and Ver:3

Ver: 2

use 2.0/2.2 agreement

Ver: 3

use 3.0/3.1 agreement

(5) Content

There are internal storage/SD card/USB storage 3 options for selecting.

When Ver:2, Server/Account/PIN code will be gray and unavailable.

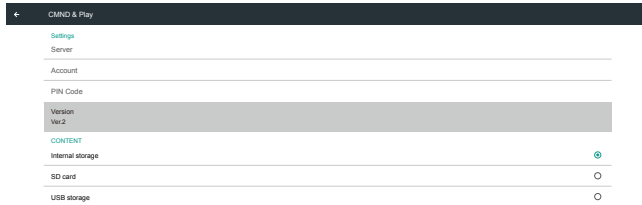

When Ver:3, Server/Account/PIN code is available.

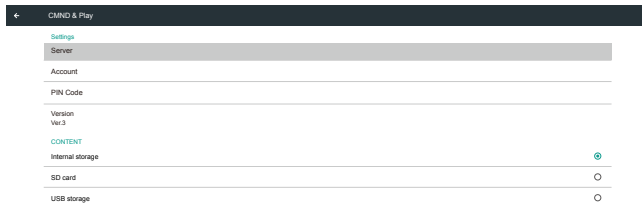

## 4.8. Custom App

User can set up the application for Customer Source

Note:

(1) Only display User Installed app.

(2) Will not show up system pre-install app.

### 4.8.1. OSD Menu operation:

RCU: Source -> Custom

If set up customer APK, PD will open customer app when switch source to Customer mode.

If no set up customer APK, PD will show Black screen when switch source to Customer mode.



### 4.8.2. Function Introduction

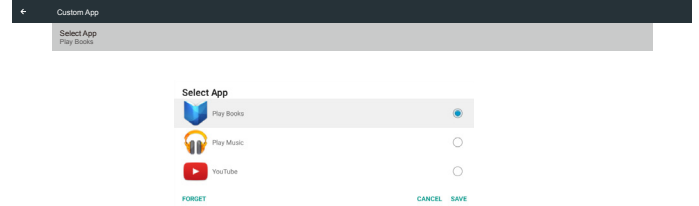

#### Save

Select the App, click the Save will perform the function of storage.

#### Forget

After press the Forget, can remove previously stored information.

#### Cancel

Don't do any change, directly closed Windows.

If no customer installed apk, the list will be blank.

The list will be blank and "Save""Forget" will be gray and useless.



If customer installed apk,user can select customer installed apk in list

- Case 1: Not set up Custom App case.

Customer app will show up and focus on first item automatically.

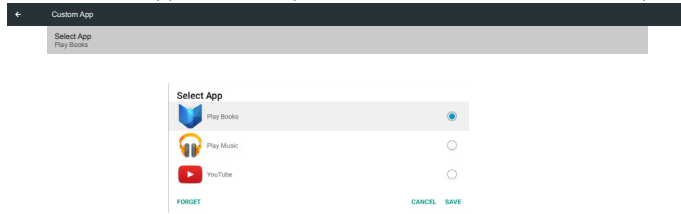

After set up, the setting screen display the app name.



- Case 2: Set up Custom App case(there is entity circle to the right of icon)

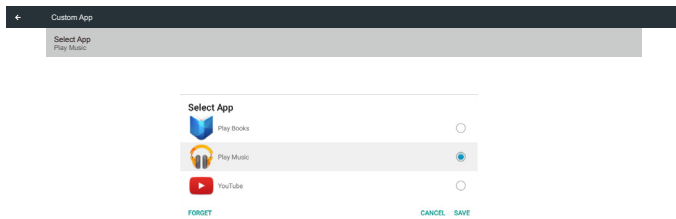

## 5. Signage display

### 5.1. Setting

Main items:

- (1) WI-Fi (Show up when plug in Wi-Fi dongle)
- (2) Ethernet
- (3) Proxy
- (4) Signage Display
- (5) System Tools
- (6) Display
- (7) Apps
- (8) Security
- (9) Date & time
- (10) Developer options
- (11) About

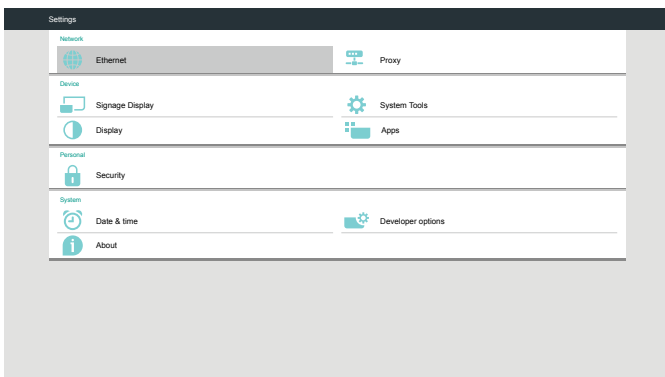

### 5.2. Wi-Fi

Via Enable/Disable to control Wi-Fi On/OFF. After Enable, the screen will list all available Wi-Fi AP.

Note :

Ethernet will be disable automatically if Wi-Fi turn on and connect to network.



### 5.3. Ethernet

Enable/Disable to turn on/off Ethernet

After enable Ethernet, the settings will show:

- (1) Connection Type (Available connection type: DHCP/Static IP)
  - A. DHCP
  - B. Static IP
  - C. IP Address
  - D. Netmask
  - E. DNS Address

### F. Gateway (2) Mac Address

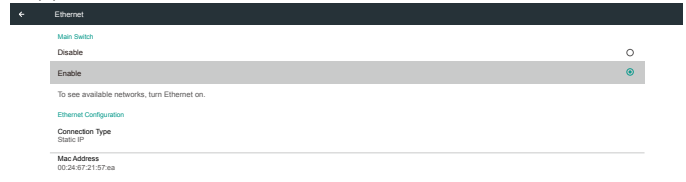

#### 5.3.1. DHCP

DHCP mode:

- (1) Cannot modify IP Address, Netmask, DNS Address and Gateway.
- (2) If connect successfully, it will display current network configuration.

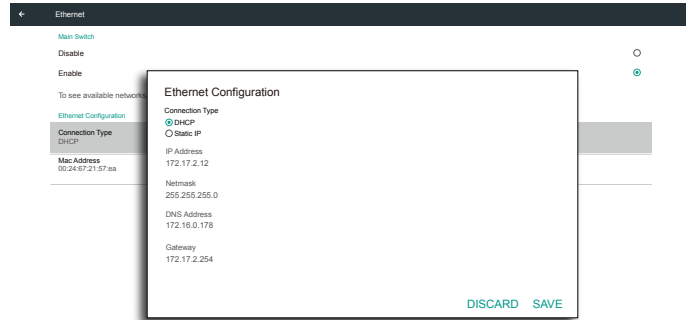

#### 5.3.2. Static IP

In Static IP mode, user can input IP Address, Netmask, DNS address and Gateway

Note:

IP address, netmask, DNS address and gateway address input limitation

- (1)Format:
  - I. number 0-9
  - II. decimal point "."

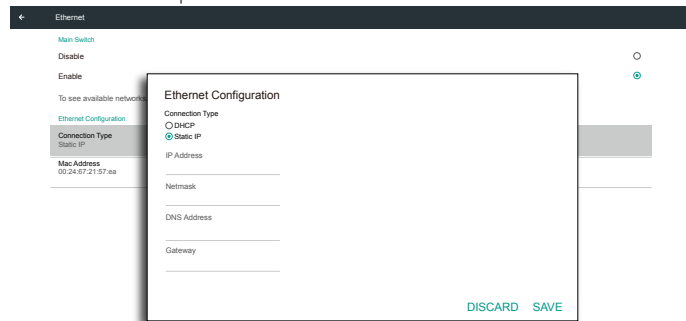



## 5.4. Proxy

Browser connect to Proxy server and ask Proxy server to connect some website on Internet.

Enable/Disable to turn on/off Proxy server:

- Click "Enable" to switch proxy function "ON"
- Input the "Proxy hostname". (Proxy server IP address)
- Input the "Proxy port". (Proxy server port number)
- Select an "Type". (Proxy server type.)
- Done.
  - If the proxy server is need an authentication to connect, please "check on" the Authentication and input Username & Password.
  - If the proxy server is not need an authentication to connect.



Note:

- Proxy type in HTTP, HTTPS, SOCKS4, SOCKS5 are support.
- Only support the connection through the proxy server with TCP port 80 & 443 & 5228.
- Proxy server with authentication on Windows Sever Series is not support.

## 5.5. Signage Display

Divide into 4 groups: General Settings / Server Settings / Source Settings / Security

- (1) General Settings
  - A. Signage Display Name
  - B. Boot Logo
  - C. Screenshot
- (2) Server Settings
  - A. Email Notification
  - B. FTP
  - C. Remote Control
  - D. SICP Network Port
- (3) Source Settings
  - A. Media Player
  - B. Browser
  - C. CMND & Play
  - D. PDF Player
  - E. Custom app
- (4) Security
  - A. External Storage
- (5) Other
  - A. TeamViewer Support
  - B. Platform Web API

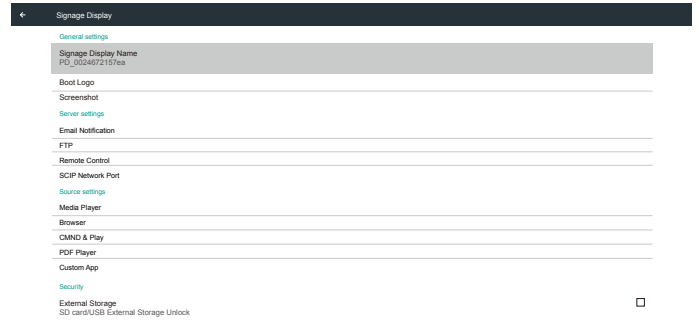

### 5.5.1. General Settings

1. Signage Display Name

Set up PD name "PD\_" + Ethernet Mac Address.

Note:

Input limitation:

- (1) length: Max 36 characters
- (2) format: no limit

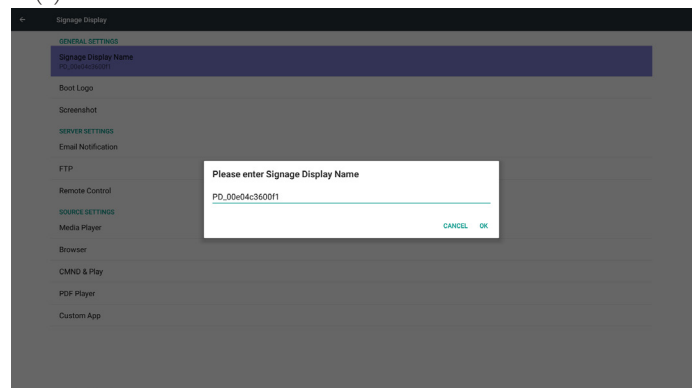

2. Boot Logo

- 1) Scalar OSD menu to control Android boot logo enable/disable  
Scalar OSD menu operation  
RCU: Home -> Configuration2 -> Logo -> On/Off/User  
In user mode, user can choose their own boot logo animation file.

Note:

- (1) Boot animation file name: bootanimation.zip
- (2) Will pop-up a window for user to select USB and SD card. No priority issue.



2) When boot logo selected, PD will check if there is bootanimation.zip under USB and SD card.

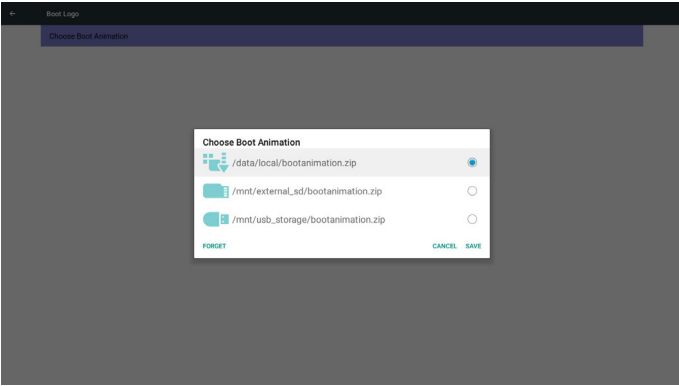

Function introduction:

a. Option description

/data/local

Use customized boot animation file which is copied from SD card or USB

/mnt/external\_sd

Use boot animations file under SD card

/mnt/usb\_storage

Use boot animations file under USB

b. Save

Press save key to save SD card or USB bootanimation.zip to /data/local and set it as boot logo.

c. Forget

Press Forget key to delete /data/local bootanimation.zip and not show boot logo.

d. Cancel

Close dialogue w/o changes.

Scenario introduction:

Case 1

The user don't settle customized boot logo. PD does not find any bootanimation.zip file under SD and USB. The list will be blank. Save and Forget button will be gray and useless.

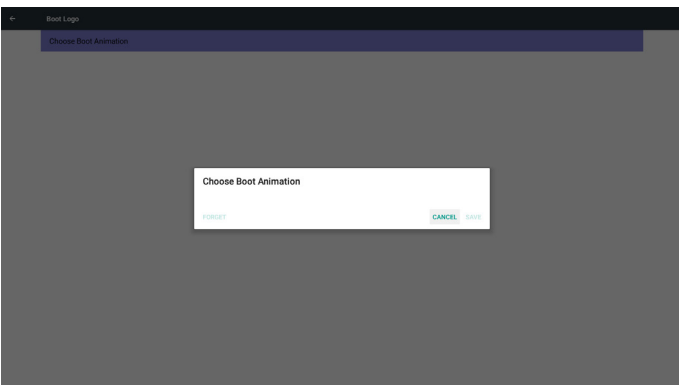

Case 2

The users do not settle customized boot logo. PD find bootanimation.zip file under SD and USB. The screen will show bootanimation.zip and select the first file automatically.

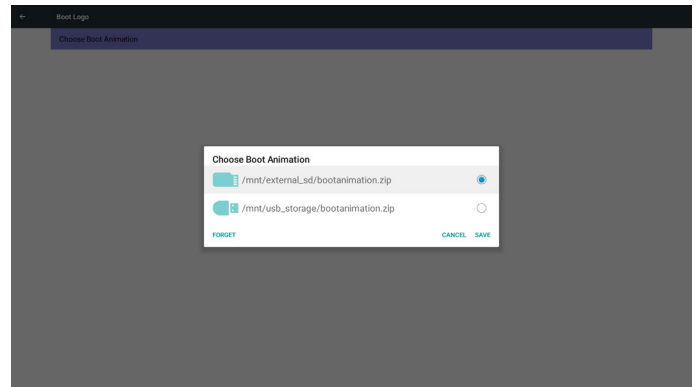

Case 3

The user settle customized boot logo, the screen will show /data/local/bootanimation.zip.

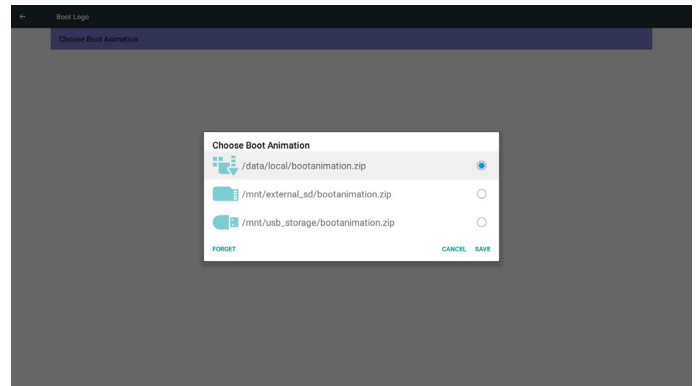

3) If OSD menu Logo item is On or Off, the users cannot choose boot animation in Android settings.



3. Screenshot

Via Enable/Disable to control screenshot On/Off.

After Enable, user can set screenshot timeslot and save path.

Note:

Time slot of deletion and screenshot:

- (1) Will delete picture at initial time 0 sec.
- (2) Will screenshot at first 40 sec.
- (3) Media player, Browser, CMND & play, PDF reader, Custom source are supported.
- (4) Screenshot will not include video container



Note :

- (1) If no End time, the screen will show current time automatically
- (2) Start time cannot be newer than End time. It will show error toast.

4)Repeat

Set screenshot repeat cycle. User can choose screenshot time frame. (Multiple selection)

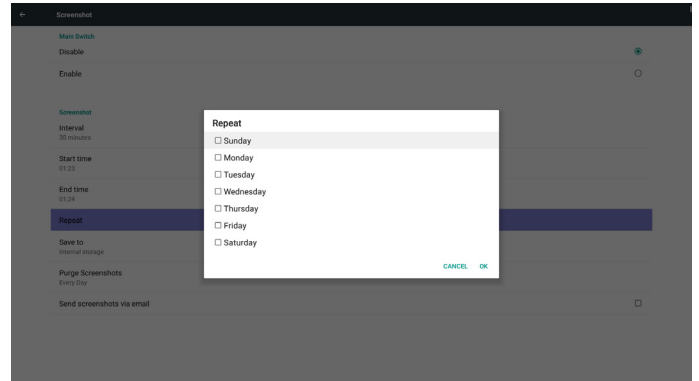

5)Save to

Set up screenshot save path. Internal storage, SD card or USB storage.)

Note:

picture storage path

- (1) In root of internal storage/usb storage/sd card, PD will create folder automatically.
- (2) The picture will save to philips/Screenshot/.

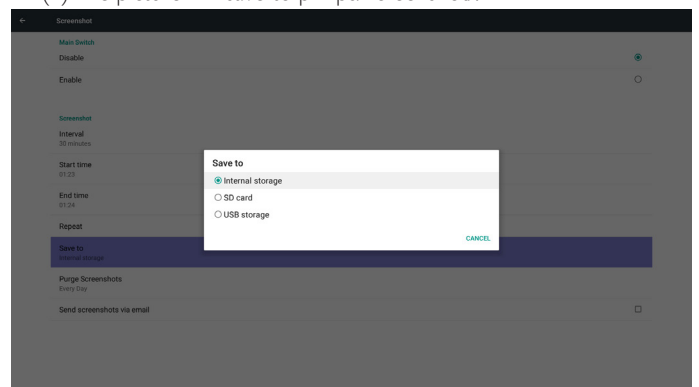

6) Purge Screenshots

Set up purge timeframe. One day or One week.

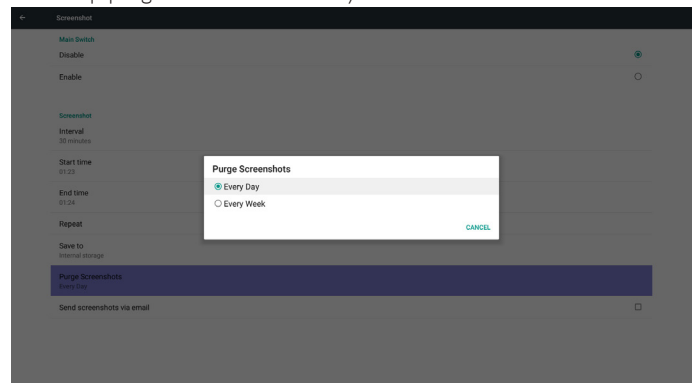

1) Interval

Set up interval timeframe. 30 mins or 60 mins.

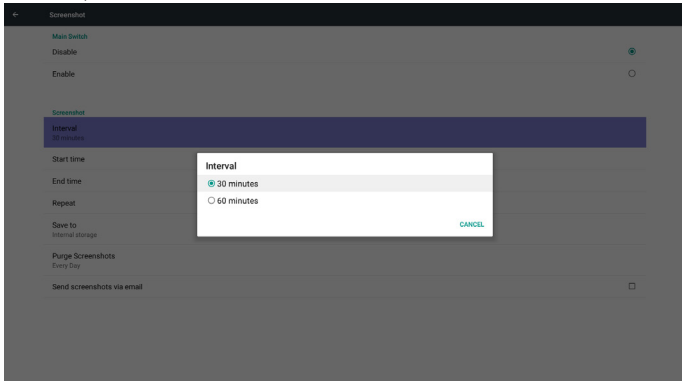

2) Start Time

Set up screenshot start time.

Note:

- (1) If no start time, the screen will show current time automatically
- (2) Just press Back key to exit dialog for Set up
- (3) Start time cannot be newer than End time. It will show Error toast.

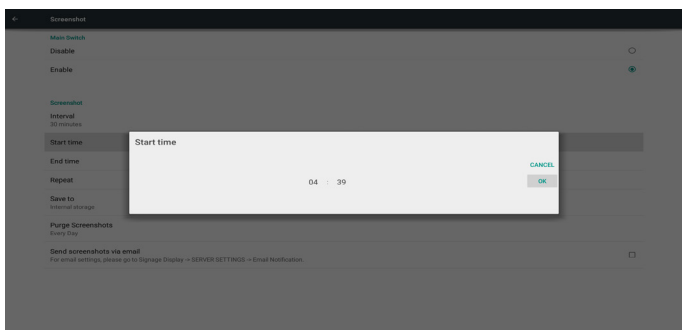

3) End Time

Set up screenshot End time

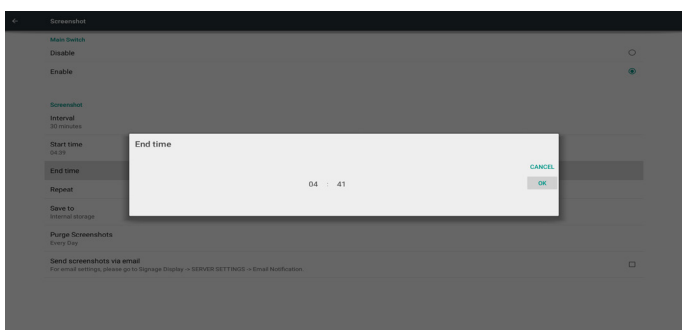

(7) Send screenshots via email

After check this item, it will send screenshot to email of administrator

Please refer to Email notification

Note:

Please confirm Email setting is done.

## 5.5.2. Server Settings

### 1. Email Notification

Via Enable/Disable to control Email On/Off)

After Enable, user can set up Email notification configuration.

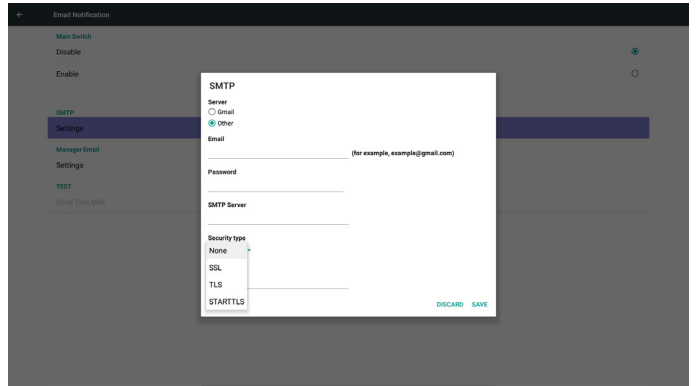
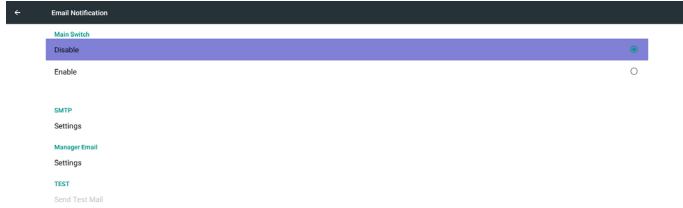

Gmail safety setting

If Gmail is not working when the settings are completed, please test the Gmail account via a PC and the below link

<https://www.google.com/settings/security/lesssecureapps>

And confirm on "Access for less secure apps" the "Turn on" item is selected.

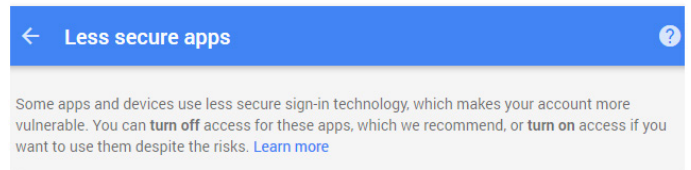

### 1) SMTP

Set SMTP configuration)

User can set Gmail account or other mail account.

User can select other mail account and set up SMTP server; Security type and port item

Note

Password input limitation

(1) Length: 6-20 characters

(2) Format: no limit

(3) unavailable port: 5000

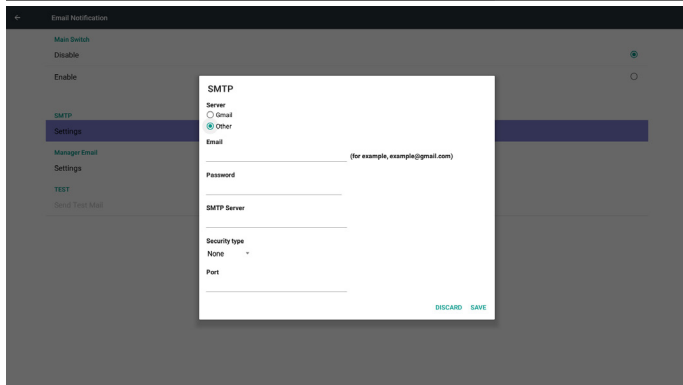
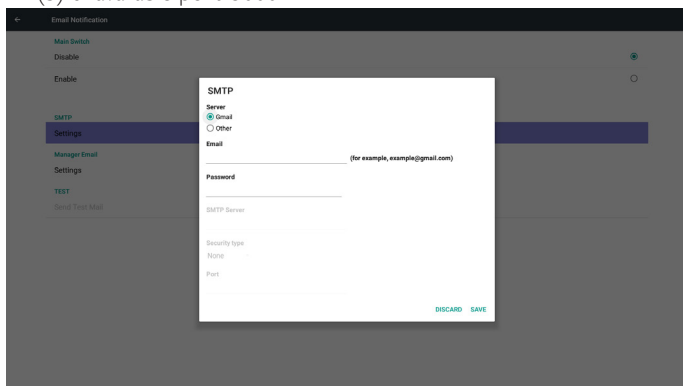

Yahoo Email Security Setting

If Yahoo Email is not working when setting complete, please confirm "Allow apps that use less secure sign in" item is enabled.

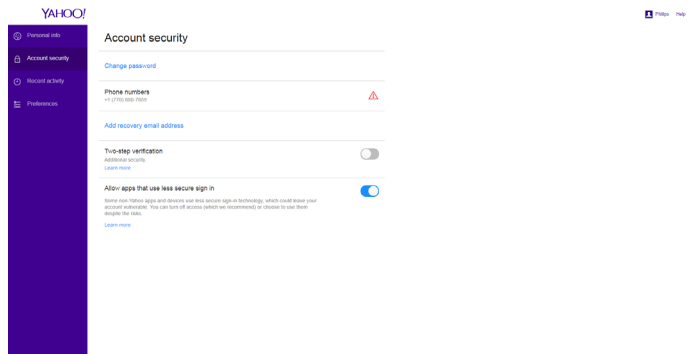

### 2) Manager Email

Email

Set up Receiver mail account

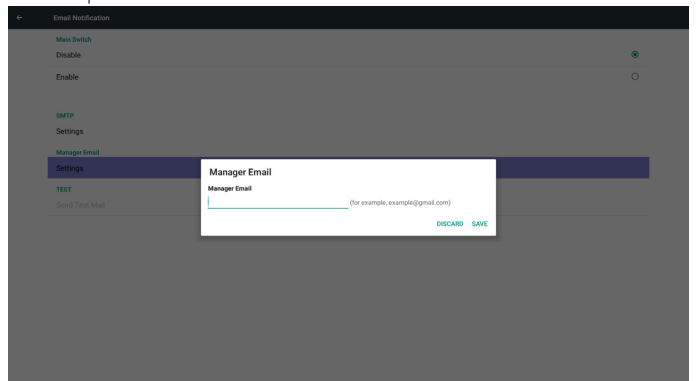

### 3)Test

Send Test Mail

To test Gmail account receive/send function.

Note

(1) When Email is Disable, "Send Test Mail Button" button will gray out

### 2. FTP

Via Enable/Disable to control FTP On/Off. After set up, PD can share FTP files.

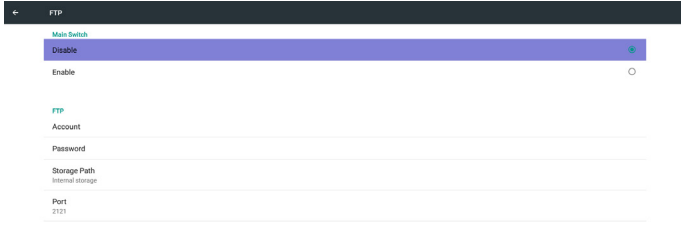

#### 1) Account

Set up FTP account

Note:

Input limitation

(1) Length: 4-20 characters

(2) Format:

- I. English a-z and A-Z
- II. Number 0-9

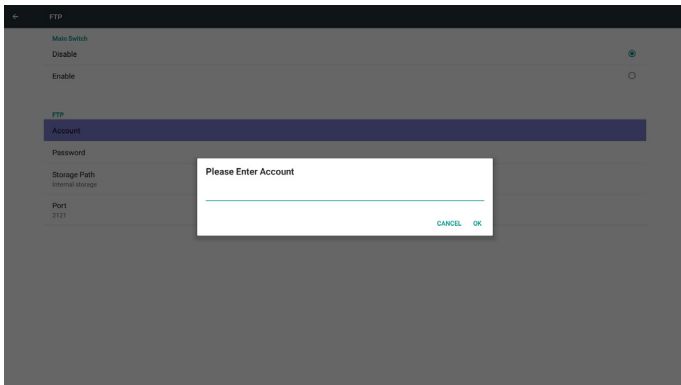

#### 2) Password

Set up FTP password.

Note:

Input limitation

(1) Length: 6-20 characters

(2) Format:

- I. English a-z and A-Z
- II. Number 0-9

FTP password display

(1) Will show "\*" symbol to instead password if set up password via remote control.

(2) After set up, the password text will show as "\*" symbol.

Before password input:

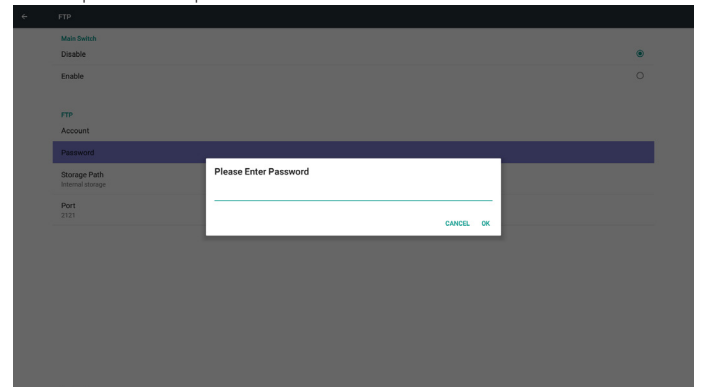

After password input:

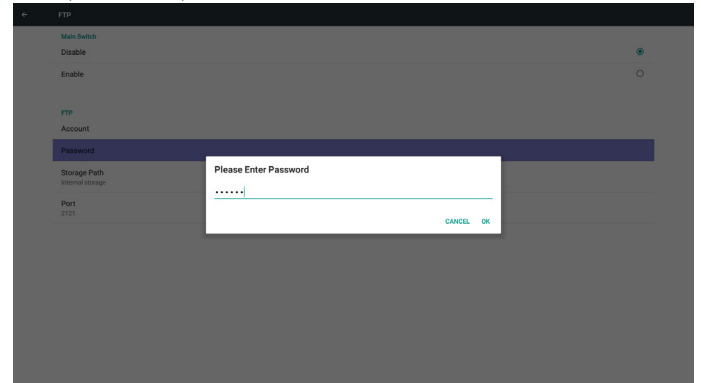

Set up completed screen:

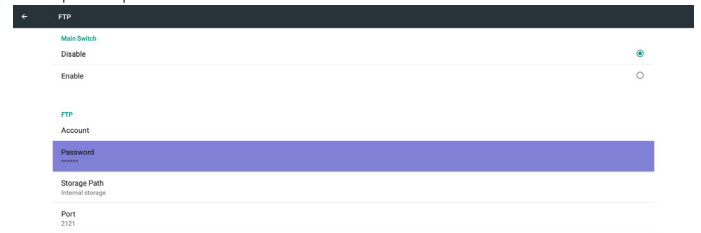

### 3)Storage Path

Show default path: Internal storage

Note:

Can only display Internal storage, cannot be modified.(Only show path)

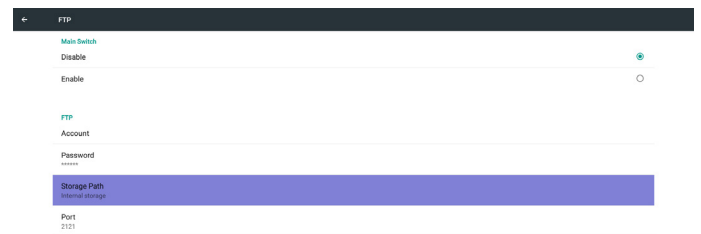

4) Will show Server is unbinded if Remote control server feedback unbinded status.

5) Port

Set up FTP port number: Default: 2121

Note:

Input limitation

- (1) Length: Max 5 characters
- (2) Range: 1024 ~ 65535
- (3) Format: Number 0-9
- (4) Unavailable port: 5000
- (5) The port number must more than 1024

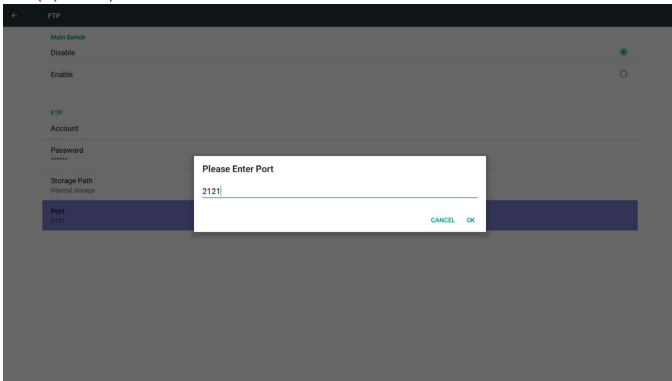

(3) Will show Server is unbinded if Remote control server feedback unbinded status.

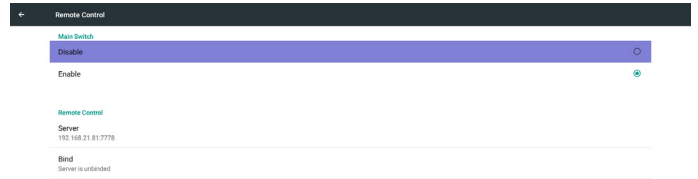

(4) Will show Server is binded if Sever binded successfully.

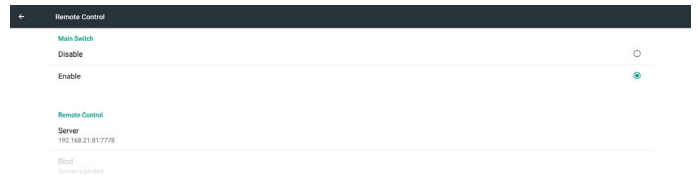

(5) Will show Error PIN code if input incorrect PIN code.

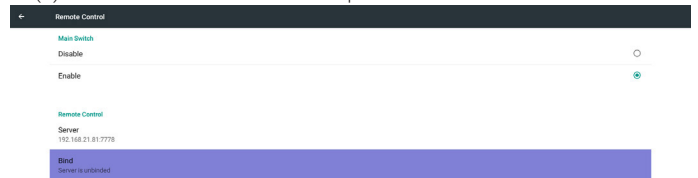

### 3. Remote Control

Via Enable/Disable to Control Remote Control On/Off

User can input Server address. If server does not registered, it will ask user for PIN code.

Bind status:

(1) Will show network is disconnected if not yet connects to network.

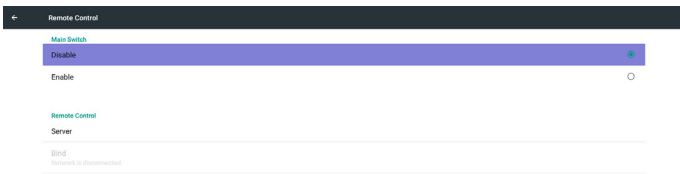

(2) Will show Server is disconnected if network connected but remote control server disconnected.

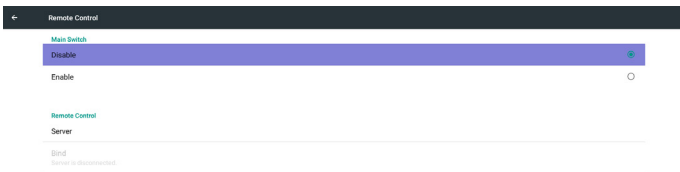

### 4. SICP Network Port

Change SICP Network Port.

Note:

1. Range: 1025-65535
2. unavailable port: 8000 / 9988 / 15220 / 28123 / 28124

### 5.5.3. Source Settings

#### 1. Media Player

Can Edit Media Player play list and effect settings.



(1) Open Media Player Player List edit page.

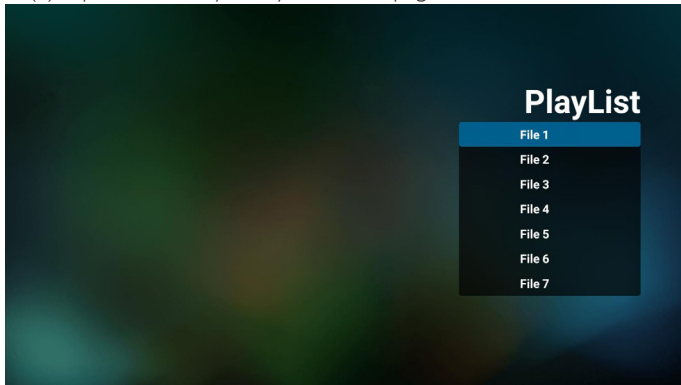

(2) Open Media Player slideshow effect edit page.

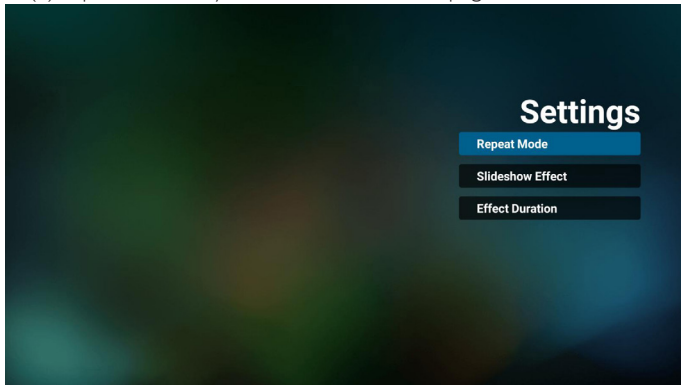

#### 2. Browser

Can edit Bookmark configuration.



Open Browser setting page.

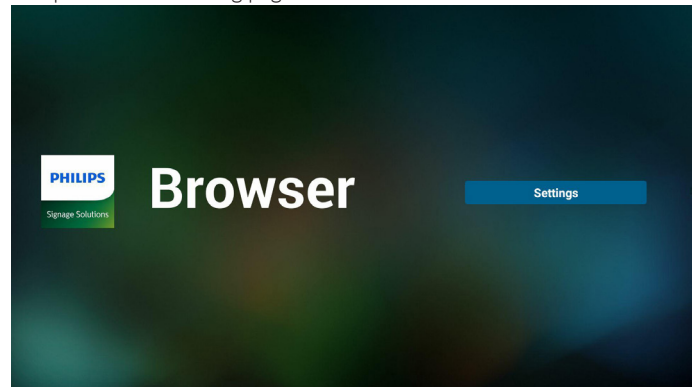

#### 3. CMND & Play

##### 1) Server

Setup CMND & Play server address

##### 2) Account

Setup CMND & Play account

##### 3) PIN Code

Setup CMND & Play PIN code

##### (4) Version

There are two options, Ver.2 and Ver.3

Ver. 2

use 2.0/2.2 agreement

Ver. 3

use 3.0/3.1 agreement

##### (5) Content

There are internal storage/SD card/USB storage 3 options for selecting.

When Ver.2, Server/Account/PIN code will be gray and unavailable.

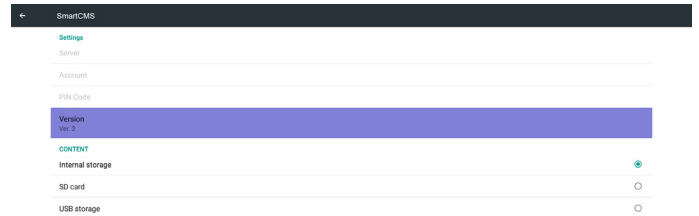

When Ver.3, Server/Account/PIN code is available.

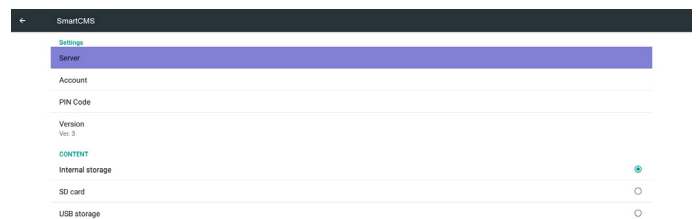

#### 4. PDF Player

(1) Open PDF Player Player List edit page.

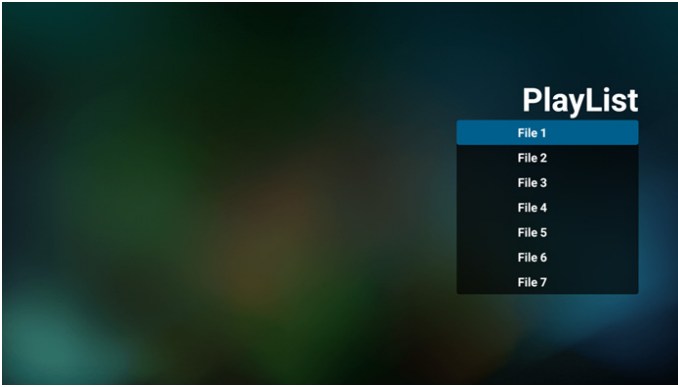

(2) Open PDF Player effect edit page.

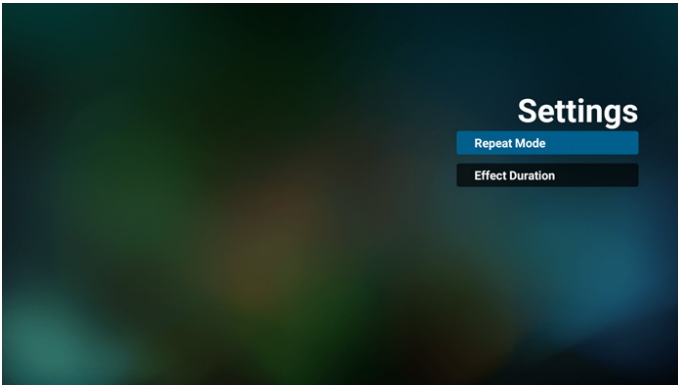

#### 5. Custom App

User can set up the application for Customer Source.

Note

(1) Only display User Installed app.

(2) Will not show up system pre-install app.

Scalar OSD menu operation

RCU: Source -> Custom

If set up customer APK, PD will open customer app when switch source to Customer mode.

If no set up customer APK, PD will show Black screen when switch source to Customer mode.



#### Function introduction

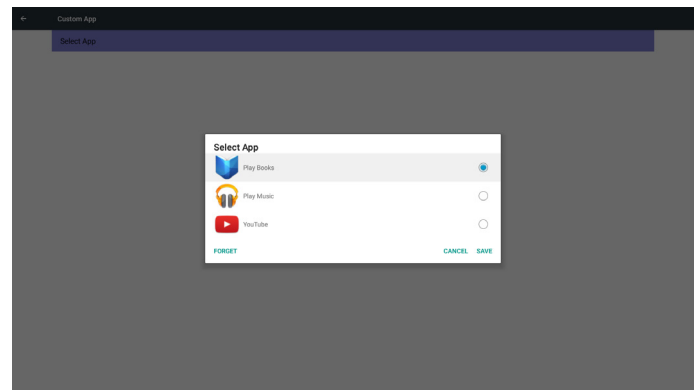

(1) Save

Select App and press Save key to save it.

(2) Forget

Press Forget key to clean previous stored data

(3) Cancel

No change, close window directly

If no customer installed apk, the list will be blank.

No option to choose. Save and Forget key will be gray and unavailable.

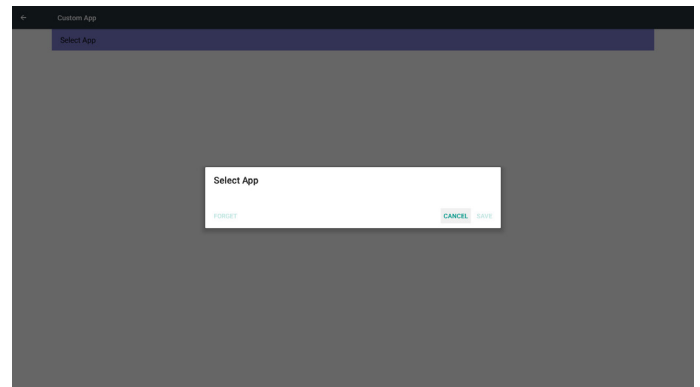

User can select customer installed apk in list

No setup Custom App

Screen will show available apps and focus on first app item automatically.

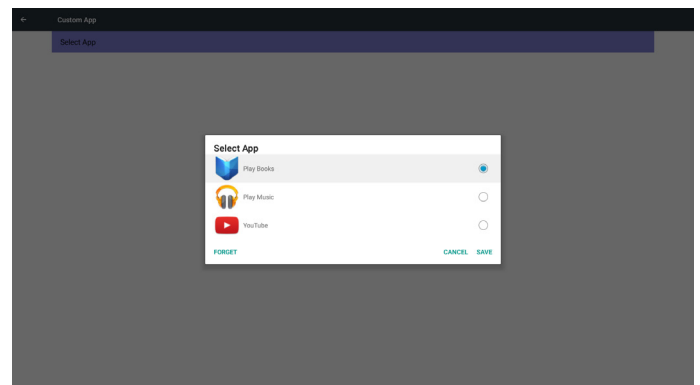



After setup, it will show App name



Case2. Setup Custom App. (there is a checked circle on right)

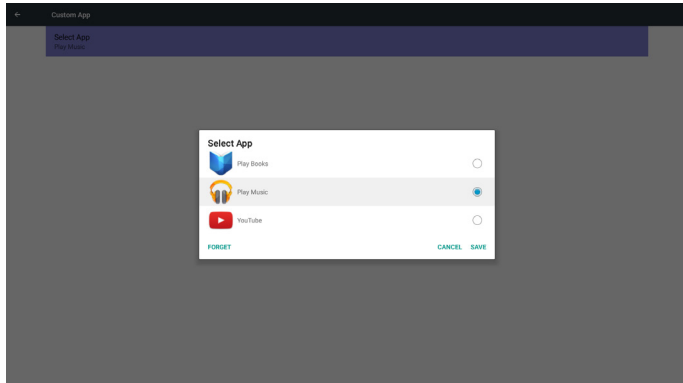

### 5.5.4. Security

#### 1. External Storage

Enable: SD card/USB External Storage Lock.

Disable: SD card/USB External Storage Unlock.

Note:

Must re-plug SD card/USB External Storage after unlock the external storage.

### 5.5.5. Other

#### (1) TeamViewer Support

Enable / Disable TeamViewer support.

#### (2) Platform Web API

Enable / Disable Platform Web API.

## 5.6. System Tools

System tools 4 main functions:

- (1) Clear Storage
- (2) Factory Reset
- (3) Import & Export
- (4) Clone Media Files

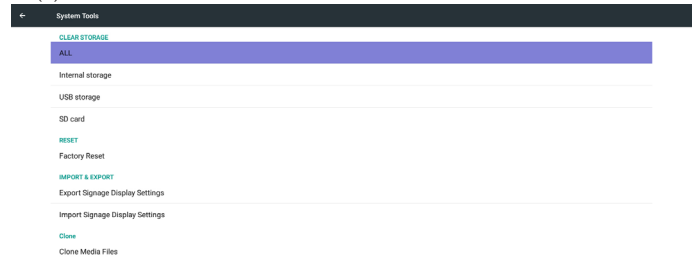

### 5.6.1. Clear Storage

The purpose is to clear all data in Philips folders.

Divided into 4 mode:

- (1) Clear all Philips folders
- (2) Only clear Philips folder under Internal storage.
- (3) Only clear Philips folder under USB storage.
- (4) Only clear Philips folder under SD card.

Pop-up the window to display all folders which can be clear:

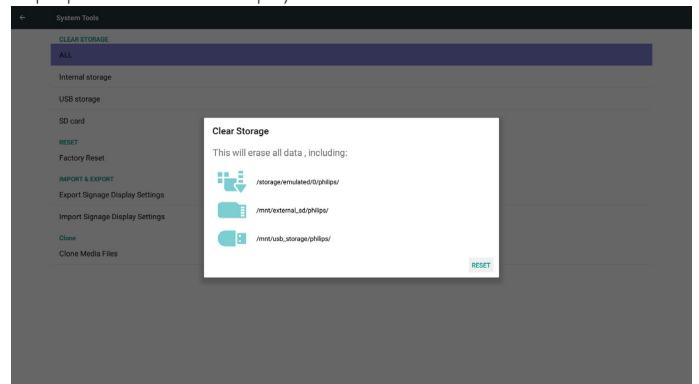

### 5.6.2. Factory Reset

Factory Reset can recover to Factory default settings.

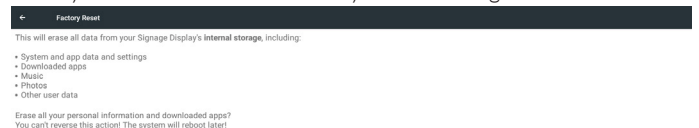

FACTORY RESET

Press OK to execute Reset function automatically.

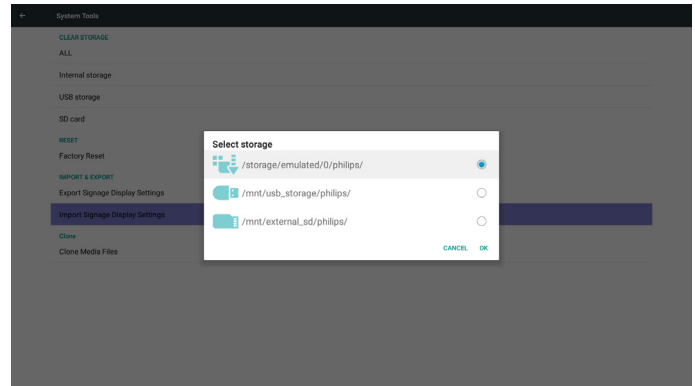
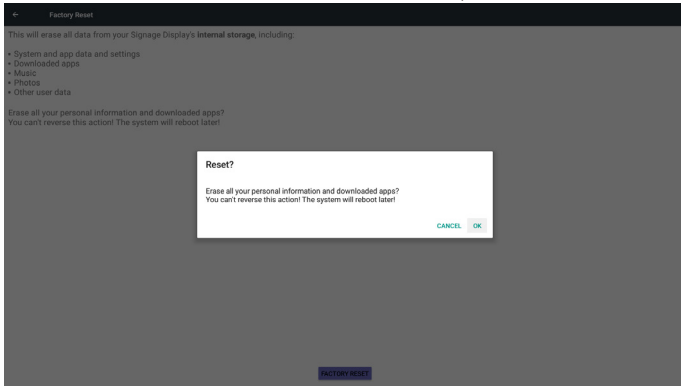

Show notification dialog before database import

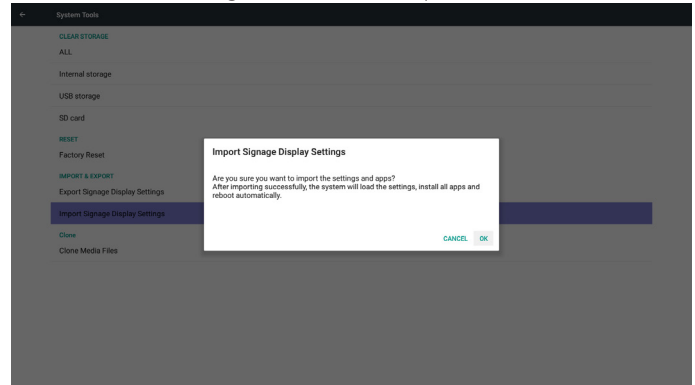

### 5.6.3. Import & Export

The function of Import & Export PD settings.

Notes.

- (1) Settings.db (Saved file name: settings.db)
- (2) Will save to Philips folder in storage

#### 5.6.3.1. Export Signage Display Settings

Will export to Philips folder under USB or SD card

- (1) Export settings.db. Include OSD setting, Android settings but "Signage Display Name" and "Boot Logo"
- (2) Export 3<sup>rd</sup> party apk to Philips/app/

Note:

If no Philips folder exists in USB or SD card, it will be created automatically.

List all available storage (internal/SD/USB)

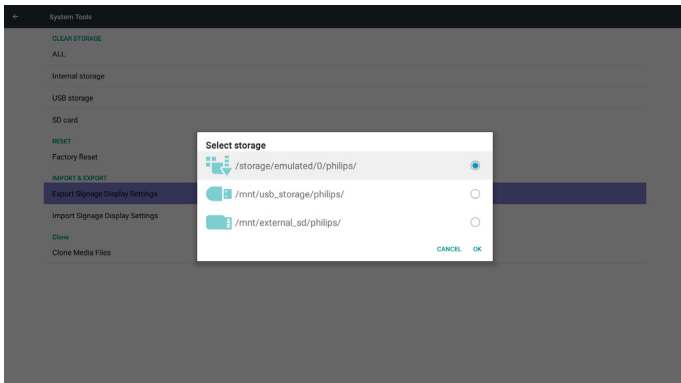

#### 5.6.3.2. Import Signage Display Settings

Import settings.db from Philips folder under USB or SD card.

- (1) Import settings.db. Include OSD setting, Android settings but "Signage Display Name" and "Boot Logo"
- (2) Auto install 3<sup>rd</sup> party apk from Philips/app/

List all available storage (Internal/SD/USB)

### 5.7. Clone Media File

Clone media file from Internal, SD or USB Philips folder:

1. The cloned folder name under Philips folder

- (1) philips/photo
- (2) philips/music
- (3) philips/video
- (4) philips/cms
- (5) philips/pdf
- (6) philips/browser

2. The cloned file extension name is ".cms")

Clone Source

- (1) Internal storage
  - (a) check FTP
  - (b) check /Philips/
- (2) SD / USB

Files under root

Target Location

- (1) Internal storage
 

Save to /Philips/
- (2) SD / USB
 

Save to root

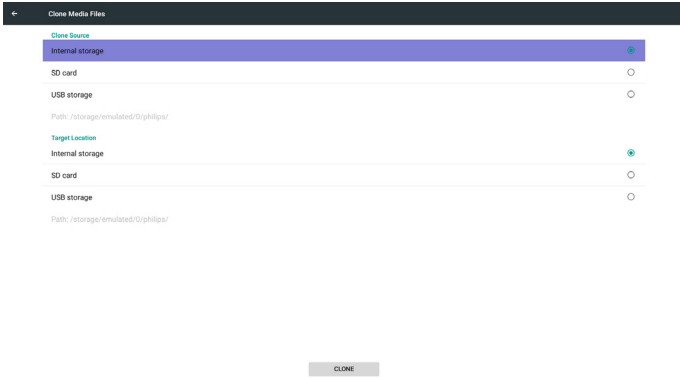

## 5.8. Display

User can modify the font size, can choose: Small/Normal/Large/Huge



## 5.9. Apps

Display applications information.

Note

- (1) User options key on RCU to show setting option.



No apps.

## 5.10. Security

- (1) Credential storage  
Control panel of certificates

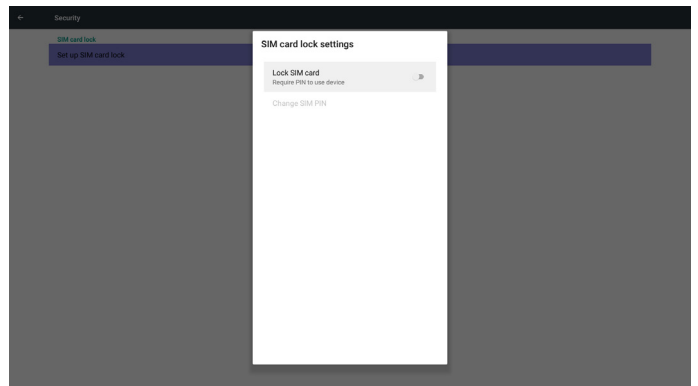
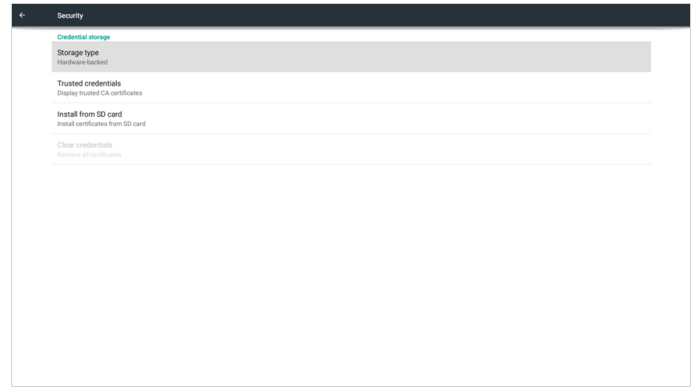

## 5.11. Date & time

Via Scalar OSD menu to control Auto Time On/Off.

Note:

Add new NTP server to display current server IP.



## 5.12. Developer options

Android developer options. For more information please visit <https://developer.android.com/index.html>

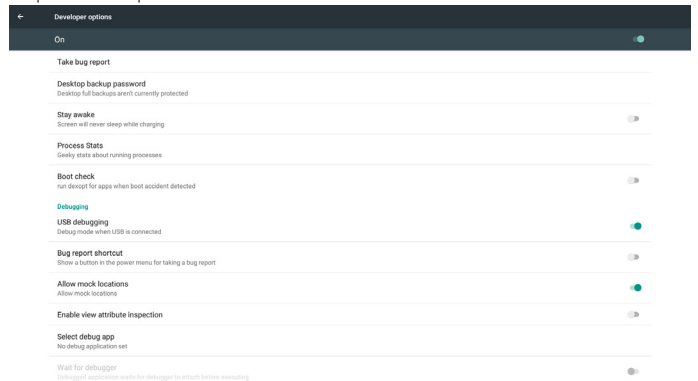

## 5.13. About

Main info in About:

- (1) System updates
- (2) Android version
- (3) Kernel version
- (4) Build number

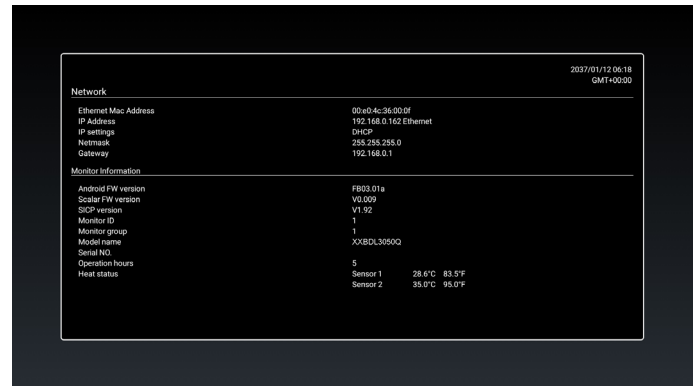
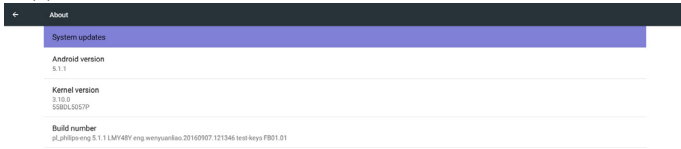

## 5.14.2. How to custom an Android boot animation?

1. Overview

The Android boot animation is used script to load PNG files when the device boots. It is contained within an **uncompressed** zip file called **bootanimation.zip**.

2. Inside the bootanimation.zip file

The bootanimation.zip as follow:

- The image folder (Contains PNG images named in incremental numbers)
- The desc.txt file

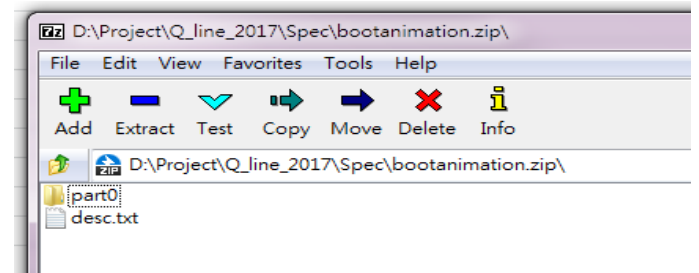

- (1) The image folder

These contain PNG images named in numbers, starting from something like 0000.png or 0001.png and proceeding with increments of 1. There has to be at least one folder and there is no known upper limit to the number of folders.

- (2) The desc.txt file

This file defines how the images in the folder(s) are displayed during the boot animation, in the following format:

- Width Height Frame-rate
- mode Loop delay-time Folder1
- mode Loop delay-time Folder2

An example of a desc.txt file is:

- 1920 1080 30
- p 1 0 part0
- p 0 0 part1

a. The first line

1920 and 1080 define the width and height of the screen resolution.

30 is the frame rate in fps (frames per second) i.e. number of images to display per second.

b. The second and third lines have a same format.

## 5.13.1. System updates

Will automatically search update.zip in USB.

Will be shown in list for user selection if found

Note:

- (1) Only support Android Full image.
- (2) file name should be update.zip.
- (3) the file should be located in root of storage.

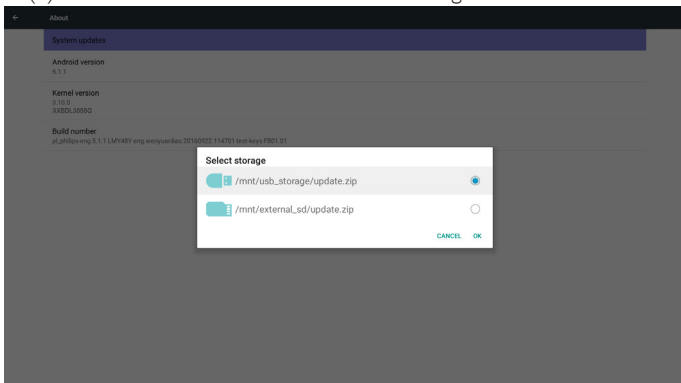

After select update.zip file, PD will restart and start to update.

## 5.14. Supplementary

### 5.14.1. Quick Info

You can press "Info + 77" to startup quick info.

Quick info will show "Network" and "Monitor Information", as below:

Note:

Operation hours : It is updated every minute.

Heat status : It is updated every 5 seconds.

The first 'p' defines play mode is immediately stop playing when boot complete.

The number after 'p' defines repeat mode

- specifying 0 would make the part loop indefinitely till the device has boot complete.
- specifying 1 would make the part playback once.

The next number defines the delay time(ms). For example, if set 10, when all image files has been playback, system will delay 10ms.

The part0 and part1 are image folder name.

The above example, the boot animation will play at a resolution of 1920 by 1080 pixels, at a frame rate of 30 fps, starting with the contents of part0 folder and after playing them in one loop, switching to contents of part1 folder and playing them continuously till the device boot complete.

### 3. Zip file:

Select everything (image folders and desc.txt) inside the Bootanimation folder and zip them into a new **uncompressed zip archive** using your favorite compression utility like 7zip or WinRAR and so on.

If using 7zip, set compression level to "Store"

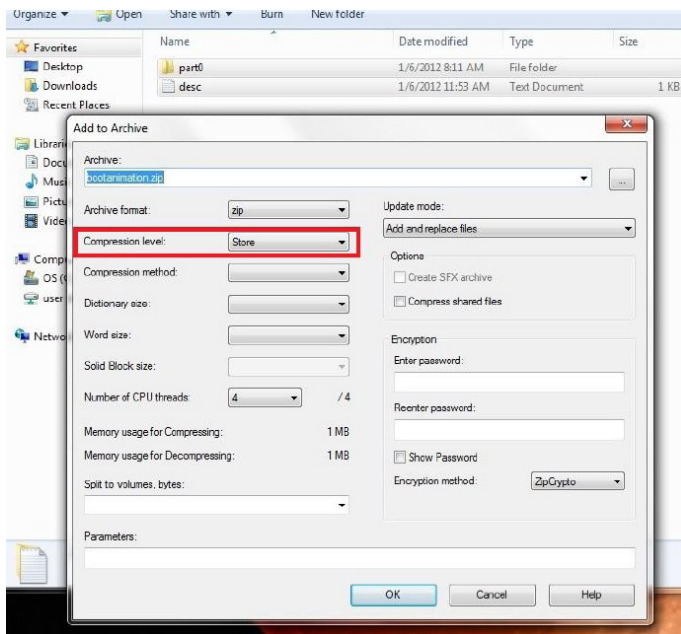

If using WinRAR, set "Compression method" to "Store"

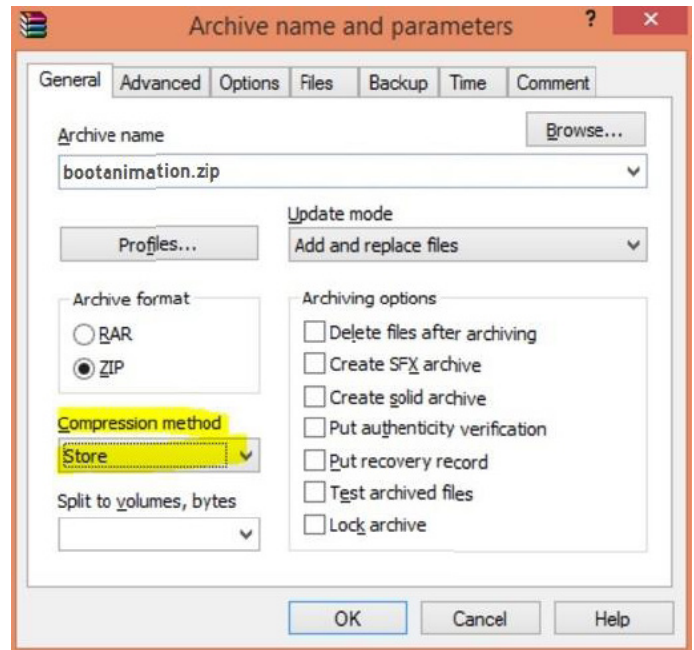

or else bootanimation WON'T work

### 4. Apply the custom bootanimation

Procedure:

(1). Put your custom bootanimztion.zip file into external SD card or USB and plug into Phillips PD platform.

(2). Make sure the Logo option is enabled.

Press Home key on RCU: OSD menu -> Configuration 2 -> Logo -> set "User"

(3). Press combination key "Home + 1888" on RCU to go to Admin mode:

Settings -> Signage Display -> GENERAL SETTINGS -> Boot Logo

(4).The system will find the bootanimation.zip in external SD card or USB automatically and copy it to /data/local

(5). Once step 1~4 has been done, restart the system.The new customized boot animation should be displayed during boot time.

### 5.14.3. How to Install Android app?

There are 3 ways to install your own android app.

(a) Via File Manager in Admin Mode

1. If you have apk already
  - 1.1 copy your apk to USB disk or SD card, and then plug them into Philips Android Signage Display.
  - 1.2 Go to Admin Mode > Apps > File Manager
  - 1.3 Using File Manager and find out your apk and then you can install. Just press "ok" on the selected apk.
2. Download apk by Chromium browser; and then go to <internal storage path>/Download/ by File Manager.
  - 2.1 The rest of steps is the same as above. Please note, each model may have different <internal storage path>.

(b) Via Adb Shell

1. Make sure that your PC can connect to Philips Android Signage Display using adb.
2. Prepare your apk in a folder(for example, C:\apkfolder) on PC.
3. Execute the following instruction by command line tool.  
C:\apkfolder> adb install -r apk\_name.apk

(c) Via Customized Intent

1. If you develop an apk which can download any android app, then your apk can issue a customized intent.
2. Giving the apk name and the path it was stored. The system will help you to install by program.

Description	Intent	Parameters	
Sw Update	php.intent.action.UPDATE_APK	filePath	The absolute file path including the file name.
		Keep	Indicate that you want to keep the file or not after updating. The default value is false.
		packageName	The target package you want to launch automatically after updating.
		activityName	The target activity you want to launch automatically after updating. But if current top activity is not activityName, nothing happened.

For example,

```
Intent intent = new Intent();
intent.setAction("php.intent.action.UPDATE_APK");
intent.putExtra("filePath", "/sdcard/Download/apk_name.apk");
intent.putExtra("keep", true);
intent.putExtra("packageName", "com.example.apk_name");
intent.putExtra("activityName", "com.example.apk_name.MainActivity");
sendBroadcast(intent);
```

## 6. OSD Menu

An overall view of the On-Screen Display (OSD) structure is shown below. You can use it as a reference for further adjusting your display.

### 6.1. Navigating the OSD Menu

#### 6.1.1. Navigating the OSD menu using the remote control

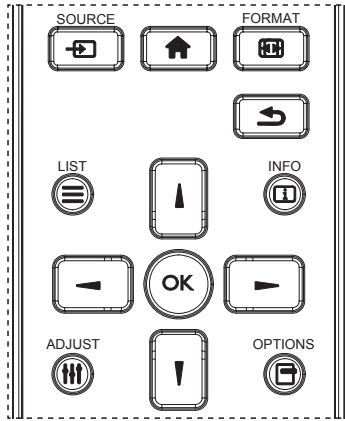

1. Press [HOME] button on the remote control to display the OSD menu.
2. Press [A] or [I] button to choose the item you want to adjust.
3. Press [OK] or [←] button to enter the submenu.
4. In the submenu, press [A] or [I] button to toggle among items, press [←] or [→] button to adjust settings. If there is a submenu, press [OK] or [→] button to enter the submenu.
5. Press [↶] button to return to the previous menu, or press [HOME] button to exit the OSD menu.

#### 6.1.2. Navigating the OSD menu using the display's control buttons

1. Press [MENU] button to display the OSD menu.
2. Press [+] or [-] button to choose the item you want to adjust.
3. Press [+] button to enter the submenu.
4. In the submenu, press [▲] or [▼] button to toggle among items, press [+] or [-] button to adjust settings. If there is a submenu, press [+] button to enter the submenu.
5. Press [MENU] button to return to the previous menu, or press [MENU] button several times to exit the OSD menu.

## 6.2. OSD Menu Overview

### 6.2.1. Picture menu

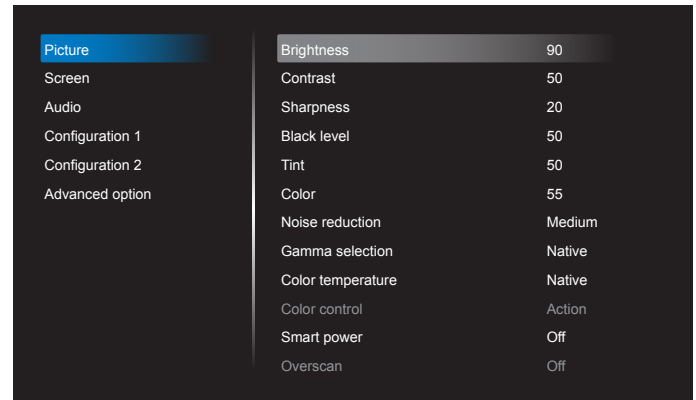

#### Brightness(Picture)

Adjust the overall image and background screen brightness(backlight).

#### Contrast

Adjust the image contrast ratio for the input signal.

#### Sharpness

This function is digitally capable to keep crisp image at any timings.

It is adjustable to get a distinct image or a soft one as you prefer and set independently for each picture mode.

#### Black level

Adjust the image brightness for the background.

NOTE: sRGB picture mode is standard and cannot be changed.

#### Tint (Hue)

Adjust the tint of the screen.

Press + button the flesh tone color becomes greenish.

Press - button the flesh tone color becomes purplish.

NOTE: VIDEO mode only.

#### Color(Saturation)

Adjust the color of the screen.

Press + button to increase color depth.

Press - button to decrease color depth.

NOTE: VIDEO mode only

#### Noise Reduction

Adjust the noise reduction level.

#### Gamma selection

Select a display gamma. It's refer to the brightness performance curve of signal input. Choose from {Native} / {2.2} / {2.4} / {s gamma} / {D-image}.

NOTE: sRGB picture mode is standard and cannot be changed.

#### Color temperature

It is used to adjust the color temperature.

The image becomes reddish as the color temperature decreases, and becomes bluish as the color temperature increases.

CCT	10000° K	9300 ° K	7500 ° K	6500 ° K	5000 ° K	4000 ° K	3000 ° K
<b>X</b>	0.279 ± 0.030	0.283 ± 0.030	0.299 ± 0.030	0.313 ± 0.030	0.346± 0.030	0.382± 0.030	0.440± 0.030
<b>Y</b>	0.292 ± 0.030	0.298 ± 0.030	0.315 ± 0.030	0.329 ± 0.030	0.359± 0.030	0.384± 0.030	0.403± 0.030

## Color control

The color levels of red, green, and blue are adjusted by the color bars.

R: Red gain, G: Green gain, B: Blue gain.

## Smart power

Smart Power control is not relative to brightness control:

- Initial setting Brightness  
70 (in the range from 0-100)  
Power consumption 70% of maximum power consumption
- Smart Power  
OFF: no adaptation  
MEDIUM: 80% of power consumption relative to current settings  
HIGH: 65% of power consumption relative to current settings

## Overscan

Change the display area of the image.

ON: Set to display area about 95%.

OFF: Set to display area about 100%.

## Picture reset

Reset all settings in the Picture menu.

Select "Yes" and press "SET" button to restore to factory preset data.

Press "EXIT" button to cancel and then return to the previous menu.

## 6.2.2. Screen menu

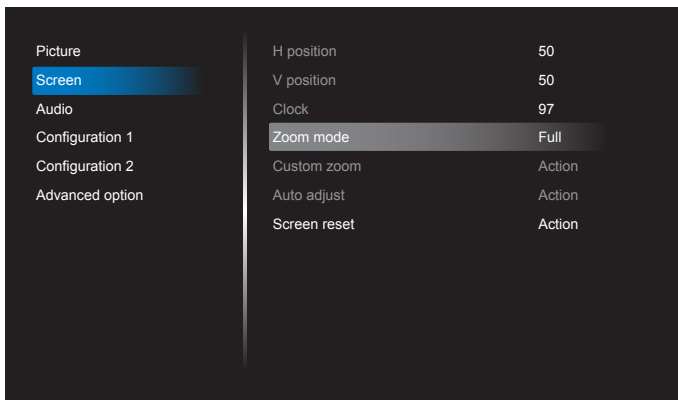

### H position

Control Horizontal Image position within the display area of the LCD.

Press + button to move screen to right.

Press - button to move screen to left.

NOTE:VGA input only.

### V position

Control Vertical Image position within the display area of the LCD.

Press + button to move screen to up.

Press - button to move screen to down.

NOTE:VGA input only.

### Clock

Press + button to expand the width of the image on the screen the right.

Press - button to narrow the width of the image on the screen the left.

NOTE:VGA input only.

## Zoom mode

HDMI, DVI, VGA: {Full} / {4:3} / {Real} / {21:9} / {Custom}.

Playing media in Media Player : {Full} / {4:3} / {Real} / {21:9}

There are no function when BROWSER, CMND & Play, PDF Player, PDF Player, Custom and Media Player UI and Android UI

Zoom Mode will be "Full" when tiling

	<b>Full</b> This mode restores the correct proportions of pictures transmitted in 16:9 using the full screen display.
	<b>4:3</b> The picture is reproduced in 4:3 format and a black band is displayed on either side of the picture.
	<b>Real</b> This mode displays the image pixel-by-pixel on screen without scaling the original image size.
	<b>16:9</b> The picture is reproduced in 16:9 format and a black band at the top and bottom.
	<b>21:9</b> The picture is reproduced in 21:9 format and a black band at the top and bottom.
	<b>Custom</b> Choose to apply the custom zoom settings in the Custom Zoom submenu.

## Custom zoom

You can use this function to further customize the zoom settings to suit the image you want to display.

NOTE: This item is functional only when the {Zoom mode} is set to {Custom}.

	<b>Zoom</b> Expands the horizontal and vertical sizes of the image simultaneously.
	<b>H zoom</b> Expands the horizontal size of the image only.
	<b>V zoom</b> Expands the vertical size of the image only.
	<b>H position</b> Moves the horizontal position of the image left or right.
	<b>V position</b> Moves the vertical position of the image up or down.



## Auto adjust

Press "Set" to detect and adjust H position, V position, Clock, Phase automatically.

NOTE:VGA input only.

## Screen reset

Reset all settings in the **Screen** menu to factory preset values.

## 6.2.3. Audio menu

Picture	Balance	50
Screen	Treble	50
Audio	Bass	50
Configuration 1	Volume	30
Configuration 2	Audio Out (Line Out)	30
Advanced option	Maximum Volume	100
	Minimum Volume	0
	Mute	Off
	Audio source	Digital
	Audio reset	Action
	Audio Out Sync	Off

### Balance

Adjust to emphasize left or right audio output balance.

### Treble

Adjust to increase or decrease higher-pitched sounds.

### Bass

Adjust to increase or decrease lower-pitched sounds.

### Volume

Adjust to increase or decrease the audio output level.

### Audio out (line out)

Adjust to increase or decrease line out output level.

### Maximum volume

Adjust your own limitation for the maximum volume setting. This stops the volume from being playing at too loud a level.

### Minimum volume

Adjust your own limitation for the minimum volume setting.

### Mute

Turn the mute function on/off.

### Audio source

Select the audio input source. There are no audio output when no video signal.

Analog: audio from audio input

Digital : audio from HDMI audio.

### Audio reset

Reset all settings in the **Audio** menu to factory preset values.

### Audio Out Sync

Enable/disable audio out (line out) volume adjustability to sync with internal speakers.

## 6.2.4. Configuration1 menu

Picture	Switch on state	Force on
Screen	Panel saving	Action
Audio	RS232 routing	RS232
Configuration 1	Boot on source	Action
Configuration 2	WOL	Off
Advanced option	Configuration1 reset	Action
	Factory reset	Action

### Switch on state

Select the display status used for the next time you connect the power cord.

- **{Power off}** - The display will remain off when the power cord is connected to a wall outlet.
- **{Forced on}** - The display will turn on when the power cord is connected to a wall outlet.
- **{Last status}** - The display will return to the previous power status (on/off/standby) when removing and replacing the power cord.

### Panel saving

Choose to enable the panel saving functions and thus reduce the risk of "image persistence" or "ghost-imaging".

- **{Brightness}** - Select **{On}** and the image brightness will be reduced to an appropriate level. The Brightness setting in the Picture menu will be unavailable when selected.
- **{Pixel shift}** - Select the time interval (**{Auto}** / **{10 ~ 900}** Seconds/ **{Off}**) for the display to slightly expand the image size and shift the position of pixels in four directions (up, down, left, or right). Activating Pixel Shift will disable H Position, V Position and Zoom Mode in the Screen Menu.

Note: Only support external input source (HDMI, VGA, DVI).

### RS232-Routing

Select the network control port.

Choose from: **{RS232}** / **{LAN -> RS232}** / **{CardOPSR232 (OPS model only)}**.

### Boot on source

Choose to select source when boot up.

Input: select input source when boot up.

Playlist: select playlist index for Media player; Browser; PDF player:

0: no play list. Same as switch source from OSD. 1~7: playlist number:

No failover function, system will keep source even the source is no signal input.

### Wake on Lan (WOL)

Choose to turn on or off the wake on LAN function.

Choose from : **{Off}** / **{ On}**

### Configuration1 reset

Reset all settings in **Configuration1** menu to the factory preset values.

## Factory reset

Reset all settings in the OSD menus of {Picture}, {Screen}, {Audio}, {Configuration1}, {Configuration2}, and {Advanced option} to the factory preset values.

Android settings will also reset when factory reset.

Press [←] or [→] button to select {Reset}, and press [OK] button to do the reset.



## 6.2.5. Configuration2 menu

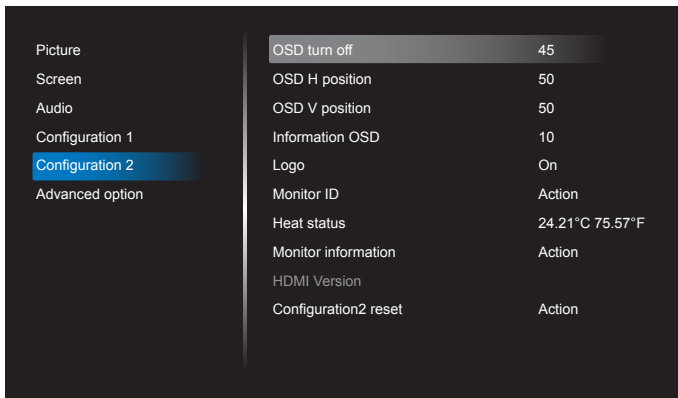

### OSD turn off

Set the period of time the OSD (on-screen display) menu stays on the screen.

The options are: {Off, 5 ~ 120} seconds.

\*{Off} does not disappear automatically.

### OSD H-position

Adjust the horizontal position of the OSD menu.

### OSD V-position

Adjust the vertical position of the OSD menu.

### Information OSD

Set the period of time the information OSD is displayed on the upper right corner of the screen. The information OSD will display when input signal is changed.

The information OSD will remain on the screen with {Off} selection.

The options are: {1 ~ 60} seconds.

### Logo

Choose to enable or disable the picture of Logo when turn on your display.

The options are:

- {Off}
- {On} (Default)
- {User}

1. If Logo set to ON, both scalar Philips logo and android animation Philips logo will show.

2. If Log set to OFF, neither scalar Philips logo nor android animation logo will not show.

3. If Logo set to USER, custom logo option in android is not set, then there will be no boot logo when power on.

4. If Logo set to USER, custom logo option in android is set, there will be only custom logo when power up.

\* Logo will NOT rotate with rotation setting/detection.

## Monitor ID

Set the ID number for controlling the display via the RS232C connection. Each display must have a unique ID number when multiple sets of this display are connected. Monitor ID number range is between 1 to 255.

The option are: {Monitor group}



- {Monitor group}

The options are: {Off} / {1-254}

- {Off} – {Monitor group} are not supported.
- {1-254} – {Monitor group} are supported. The default setting is 1.

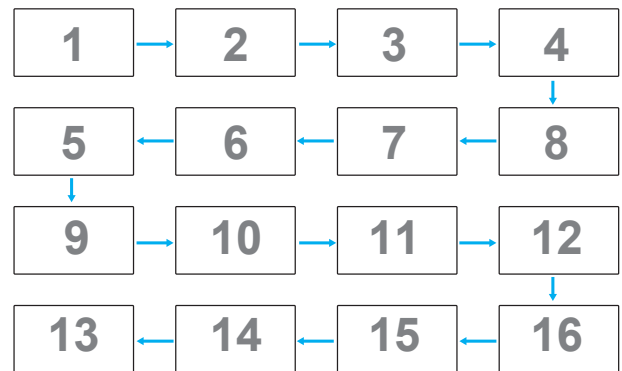

## Heat status

This function allows you to check the thermal status at any time.

## Monitor information

Shows information about your display, including model number, serial number, operating hours and software version.

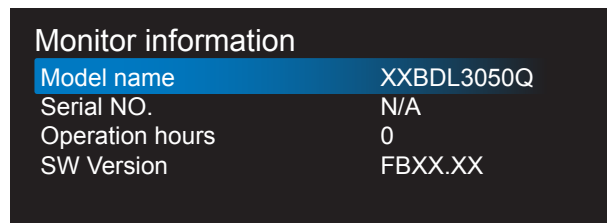

## HDMI Version

Set the HDMI version to 1.4 or 2.0, this setting is only valid on HDMI input

## Configuration2 reset

Reset all settings in Configuration2 menu to the factory preset values.

## 6.2.6. Advanced option menu

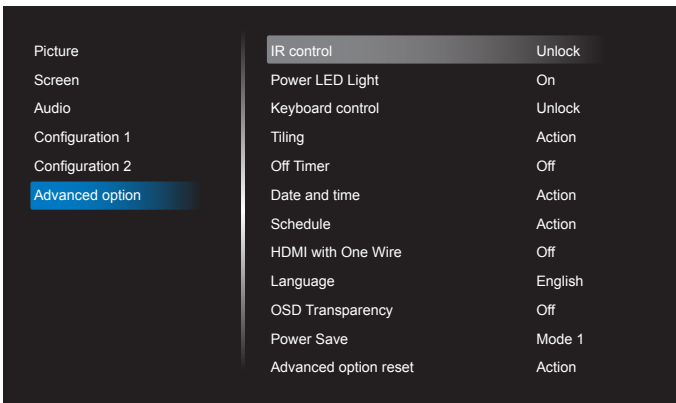

### IR control

Select the operation mode of the remote control when multiple displays are connected via an RS232C connection.

- **{Unlock}** - All displays can be operated normally by the remote control unit.
- **{Primary}** - Designate this display as the primary display for remote control operation. Only this display can be operated by the remote control. (In primary mode, IR key will always be processed regardless the monitor id/group settings).
- **{Secondary}** - Designate this display as the secondary display. This display can not be operated by the remote control, and will only receive the control signal from the primary display via the RS232C connection.
- **{Lock All} / {Lock all but Volume} / {Lock all but Power} / {Lock all except PWR & VOL}** - Lock the remote control function of this display. To unlock, press and hold the **[i]** INFO button on the remote control for 6 (six) seconds.

### Power LED light

Choose to set power indicate LED on or off.

Choose **{On}** for normal use.

### Keyboard control

Choose to enable or disable the display keyboard (control buttons) function.

- **{Unlock}** - Enable the keyboard function.
- **{Lock All} / {Lock all but Volume} / {Lock all but Power} / {Lock all except PWR & VOL}** - Disable the keyboard function.

NOTE: "Keyboard Control Lock Mode" This function completely disables the access to all Keyboard Control functions. To enable or disable the keyboard control lock, press both **[+]** and **[A]** buttons and hold down continuously for more than 3 seconds.

### Tiling

With this function you can create a single large-screen matrix (video wall) that consists of up to 150 sets of this display (**up to 10-sets on the vertical and 15-sets on the horizontal sides**). This function requires a daisy-chain connection.

- **Switch on delay:** Set the power-on delaying time (in seconds). The default option **{Auto}** allows a sequential powering-on for each display by their ID number when multiple displays are connected. The options are: **{Off (0) / Auto(1) / 2-255}**
- **Brightness:** **{Normal} / {ACS}**
  - **{Normal}**: Adjust the overall image and background screen brightness (backlight).

- **{ACS}**: Apply brightness value (backlight) which is adjusted by MIC tool. The default value before adjustment is the same as OSD brightness value, e.g., 70)
- **Type:** **{Off}** (Default) / **{SW Tool}** / **{OSD Only}**
- **Source resolution:** **{Full HD}** (Default) / **{4K}**
- **H monitors** - Select the number of displays on the horizontal side.
- **V monitors** - Select the number of displays on the vertical side.
- **Position** - Select the position of this display in the screen matrix.
- **Frame comp.** - Choose to turn the frame compensation function on or off. If selected **{Yes}**, the display will adjust the image to compensate for the width of the display bezels in order to accurately display the image.

NOTE: Doesn't support screen format function in tiling using cascade mode.

### Off Timer

Set automatically power off time (in hours).

### Date and time

Adjust the current date and time for the display's internal clock.

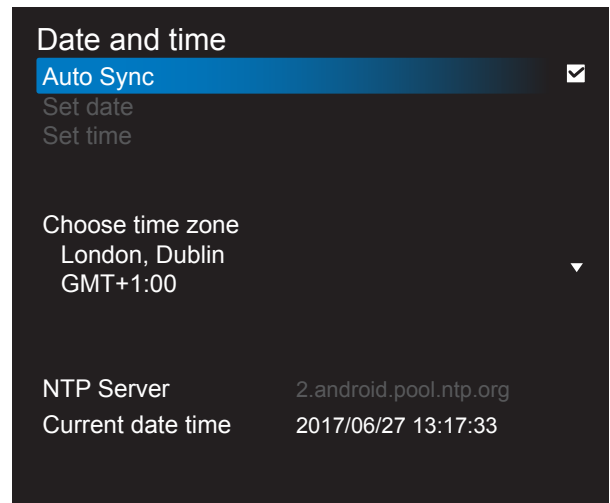

1. Press **[OK]** button to enter or choose
2. Press **[←]** back button to return.
3. Press **[▲]** or **[▼]** button to adjust them.

\* Cannot set time to date after year 2037.

### Schedule

This function allows you to program up to 7 (seven) different scheduled time intervals for the display to activate.

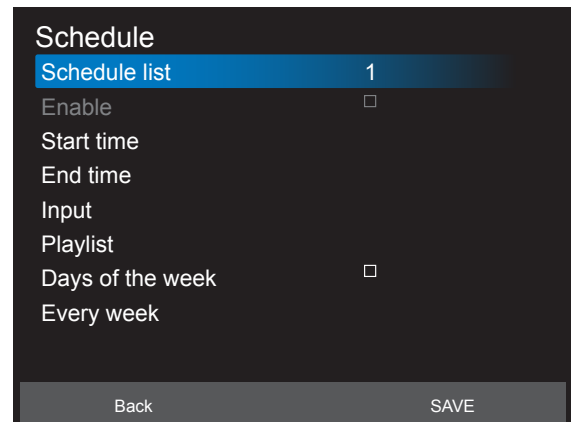

- **Schedule list:** You can set 7 schedules.
- **Enable:** Enable/disable schedule. If set start/end time is conflict or empty, input is empty or time conflict with other schedule list, you cannot enable schedule.
- **Start time:** Set start time.
- **End time:** Set end time.
- **Input:** Platform will go to this select source automatically after the schedule on.
- **Play list:** 1 - 7 : playback File1 - File7 of playlist automatically, only media player, pdf player and browser can set.
- **Days of the week:** Set Sunday, Monday, Tuesday, Wednesday, Thursday, Friday, Saturday.
- **Every week:** Set lifecycle.
- **Back:** Does not change schedule data.
- **Save:** Save schedule data.

### HDMI with One Wire

CEC control.

- {Off} - Disable CEC. (Default)
- {On} - Enable CEC.

### Language

Select the language used in the OSD menu.

The options are: English/Deutsch/ 简体中文 /Français/Italiano/Español/Русский/PolSKI/Türkçe/ 繁體中文 / 日本語 /Português/ العربية/Danish/Svenska/Finnish/Norsk/Nederlands.

### OSD Transparency

Adjust OSD transparency.

- {Off} - Transparency off.
- {1-100} - Transparency level 1-100.

### Power Save

Mode 1 [TCP off, WOL on, auto off]

Mode 2 [TCP off, WOL on, auto on/off]

Mode 3 [TCP on, WOL off, auto on/off]

Mode 4 [TCP on, WOL off, no auto on/off]

Power save modes

Mode 1: DC off -> Power off, LED: Red.

Power Save -> Power off, LED: Red

Mode 2: DC off -> Power off, LED: Red.

Power Save -> Power Saving, LED: Orange. Can be wake up.

Mode 3: DC off -> Back light off, LED: Red

Power Save -> Back light off, LED: Orange. Can be wake up.

Mode 4: DC off -> Back light off, LED: Red

Power Save -> Will not enter power save mode. show "no signal" only.

	RCU Power Button Off	No Signal	WoL	Android (ARM)
Mode 1 [TCP off, WOL on, auto off]	DC OFF	DC OFF	√	ARM OFF
Mode 2 [TCP off, WOL on, auto on/off] (garry out)	DC OFF	When signal is back, system wake up	√	ARM OFF
Mode 3 [TCP off, WOL off, auto on/off]	Backlight OFF	Backlight OFF	×	ARM OFF
Mode 4 [TCP off, WOL off, no auto on/off]	Backlight OFF	Backlight ON, show no signal	×	ARM OFF

\* This product does not support Mode 2

Following table is the action for Android board with different power mode.

DC off/on: press power button by RC

Power mode in OSD	Mode 1/2	Mode 3/4
DC off	shutdown	1. The current source APK (such as MediaPlayer, Browser, PDF or SmartCMS) will be closed. 2. Android system will go to the default black launcher.
DC on	Boot up	1. Android system reboots

### Advanced option reset

Reset all settings except {Date and Time} in the **Advanced option** menu to factory preset values.

1. Press [OK] or [▶] button to enter the submenu.
2. Press [←] or [→] button to select {Reset} and press the [OK] button to restore settings to factory preset values.
3. Press the [↶] button or select {Cancel} and press the [OK] button to cancel and then return to the previous menu.

## 7. Supported Media Formats

### USB Multimedia Codec Formats

Video Decode						
Type	Video Codec	Container	Decode	Encode	Channel	Remark
MPEG1/2	MPEG1/2	MPEG program stream (.DAT, .VOB, .MPG, .MPEG) MPEG transport stream (.ts) MP4 (.mp4) AVI (.avi) MKV (.mkv)	V			Max Resolution: 1080P@60fps Max Bit Rats : 40Mbps
MPEG-4	MPEG4	MP4 (.mp4) AVI (.avi) MKV (.mkv)	V			Max Resolution: 1080P@60fps Max Bit Rats : 40Mbps
H.263	H.263	FLV (.flv) AVI (.avi)	V			Max Resolution: 1080P@60fps Max Bit Rats : 40Mbps
H.264	H.264	FLV (.flv) MP4 (.mp4) MPEG transport stream (.ts) ASF (.asf) WMV (.wmv) AVI (.avi) MKV (.mkv)	V			Max Resolution: 1080P@60fps Max Bit Rats : 135Mbps 4K2K@30fps
H.265	H.265	MP4 (.mp4) MPEG transport stream (.ts) MKV (.mkv)	V			Max Resolution: 4K2K@60fps Max Bit Rats : 100Mbps
GOOGLEVP8	VP8	MKV (.mkv) WebM (.webm)	V			Max Resolution: 1080P@30fps Max Bit Rats : 20Mbps
Motion JPEG	MJPEG	AVI (.avi) MP4 (.mp4) MKV (.mkv)	V			Max Resolution: 1920*1080 @30fps Max Bit Rats : 40Mbps

### Audio Decode

Type	Audio Codec	Container	Decode	Encode	Channel	Remark
MPEG Audio	MPEG1/2/2.5 Audio Layer1/2/3	MP3	V		2	Bit Rate: 8kbps~320Kbps Sampling Rate: 16KHZ~48KHz
Windows Media Audio	WMA Version 7, 8, 9,10 pro M0, 10Pro M1,M10 Pro M2	Decode:WMA	V		2	Bit Rate: 8kbps~768Kbps Sampling Rate: 8KHZ~96(M10)KHz Non-support LBR
AAC Audio	MAIN,ADIF ,ATDS Header AAC-LC and AAC-HE	File Format: AAC, M4A	V		5.1	Bit Rate: N/A Sampling Rate: 8KHZ~48KHz

## Image Decode

Type	Image Codec	Photo	Decode	Encode	Channel	Remark
JPEG	JFIF file format 1.02	File Format: JPG, JPEG	V			Max Resolution: 7000 x 7000 The limitation of max resolution depends on DRAM
BMP	BMP	File Format: BMP	V			Max Resolution: 15360 x 8640 The limitation of max resolution depends on DRAM
PNG	PNG	File Format: PNG	V			Max Resolution: 15360 x 8640 The limitation of max resolution depends on DRAM

### NOTES:

- Sound or video may not work if the contents have a standard bit rate/frame rate above the compatible Frame/sec listed in the table above.
- Video content with a Bit rate or Frame rate larger than the rate specified in the table above can cause choppy video during playback.

## 8. Input Mode

### VGA Resolution:

Standard Resolution	Active Resolution		Refresh Rate	Pixel Rate	Aspect Ratio	Stand for Mode
	H Pixels	V Lines				
VGA	640	480	60 Hz	25.175 MHz	4:3	Video Graphic Array
			72 Hz	31.5 MHz		
			75 Hz	31.5 MHz		
WVGA	720	400	70 Hz	33.75 MHz	16:9	WideVideo Graphic Array
SVGA	800	600	60 Hz	40 MHz	4:3	SuperVGA
			75 Hz	49.5 MHz		
XGA	1024	768	60 Hz	65 MHz	4:3	Extended Graphic Array
			75 Hz	78.75 MHz		
WXGA	1280	768	60 Hz	79.5 MHz	5:3	Wide XGA
WXGA	1280	800	60 Hz	79.5 MHz	16:10	Wide XGA
SXGA	1280	1024	60 Hz	108 MHz	5:4	Super XGA
WXGA	1360	768	60 Hz	85.5 MHz	16:9	Wide XGA
UXGA	1600	1200	60 Hz	162 MHz	4:3	Ultra XGA
HD1080	1920	1080	60 Hz	148.5 MHz	16:9	HD1080

Note: 1280x768@60Hz can be supported but not shown in EDID table.

### SD Resolution:

Standard Resolution	Active Resolution		Refresh Rate	Pixel Rate	Aspect Ratio
	H Pixels	V Lines			
480i	720	480	29.97 Hz	13.5 MHz	4:3
480p			59.94 Hz	27 MHz	
576i	720	576	25 Hz	13.5 MHz	4:3
576p			50 Hz	27 MHz	

### HD Resolution:

Standard Resolution	Active Resolution		Refresh Rate	Pixel Rate	Aspect Ratio
	H Pixels	V Lines			
720p	1280	720	50 Hz	74.25 MHz	16:9
			60 Hz		
1080i	1920	1080	25 Hz	74.25 MHz	16:9
			30 Hz		
1080p	1920	1080	50 Hz	148.5 MHz	16:9
			60 Hz		
2160p (HDMI only)	3840	2160	30 Hz	297 MHz	16:9
			50 Hz	594 MHz	
			60 Hz		

- The PC text quality is optimum in HD 1080 mode (1920 x 1080, 60Hz).
- Your PC display screen might appear different depending on the manufacturer (and your particular version of Windows).
- Check your PC instruction book for information about connecting your PC to a display.
- If a vertical and horizontal frequency-select mode exists, select 60Hz (vertical) and 31.5KHz (horizontal). In some cases, abnormal signals (such as stripes) might appear on the screen when the PC power is turned off (or if the PC is disconnected). If so, press the [INPUT] button to enter the video mode. Also, make sure that the PC is connected.
- When horizontal synchronous signals seem irregular in RGB mode, check PC power saving mode or cable connections.
- The display settings table complies to the IBM/VESA standards, and based on the analog input.
- The DVI support mode is regarded as same to the PC support mode.
- The best timing for the vertical frequency to each mode is 60Hz.

## 9. Pixel Defect Policy

We strive to deliver the highest quality products and use some of the industry's most advanced manufacturing processes whilst practicing stringent quality control. However, pixel or sub-pixel defects on the PDP / TFT panels used in Plasma- & LCD- displays are sometimes unavoidable. No manufacturer can guarantee that all panels will be free from pixel defects, but Philips guarantees that any Plasma- & LCD- displays with an unacceptable number of defects will be repaired during the warranty period in line with your local guarantee conditions.

This notice explains the different types of pixel defects and defines the acceptable defect level for the LCD screen. In order to qualify for repair under warranty, the number of pixel defects must exceed a certain level as shown in the reference table. If the LCD screen is within specification a warranty exchange / claim back will be refused. Additionally, because some types or combinations of pixel defects are more noticeable than others, Philips sets even higher quality standards for those.

### 9.1. Pixels and Sub-Pixels

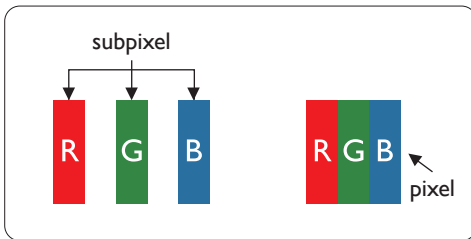

A pixel, or picture element, is composed of three sub-pixels in the primary colors of red, green and blue. Many pixels together form an image. When all sub-pixels of a pixel are lit, the three colored sub-pixels together appear as a single white pixel. When all are dark, the three colored sub-pixels together appear as a single black pixel. Other combinations of lit and dark sub-pixels appear as single pixels of other colors.

### 9.2. Types of Pixel Defects + Dot Definition

Pixel and sub-pixel defects appear on the screen in different ways. There are three categories of pixel defects and several types of sub-pixel defects within each category.

#### Dot definition = What is a defective "Dot"?

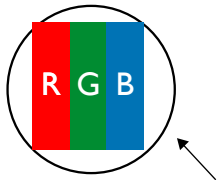

One or more defective, adjacent sub-pixel are defined as one "dot". The no. of defective sub-pixels are not relevant to define a defective dot. This means that a defective dot can consist of one, two or three defective sub-pixels which can be dark or lit.



One dot = One Pixel; consists of three sub-pixels of Red, Green, and Blue.

### 9.3. Bright Dot Defects

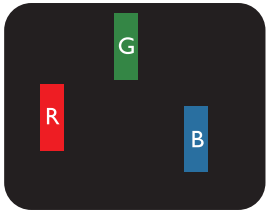
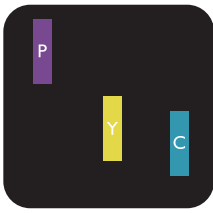
Bright dot defects appear as pixels or sub-pixels that are always lit or "on". These are the examples of bright dot defects:

 <p>One lit red, green or blue sub pixel</p>	 <p>Two adjacent lit sub pixels:            Red + Blue = Purple            Red + Green = Yellow            Green + Blue = Cyan (Light Blue)</p>	 <p>Three adjacent lit sub pixels (one white pixel)</p>
---	--	--



## 9.4. Dark Dot Defects

Black dot defects appear as pixels or sub-pixels that are always dark or "off". These are the examples of black dot defects:

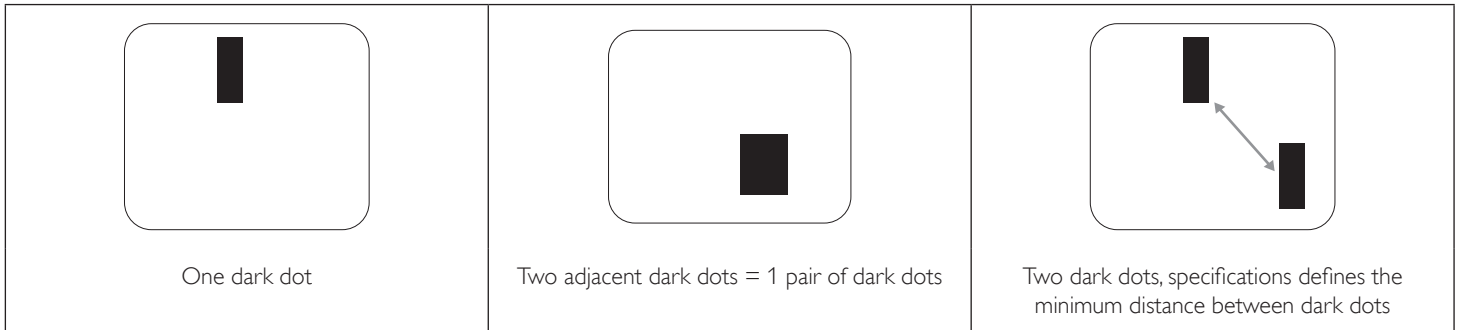

## 9.5. Proximity of Pixel Defects

Because pixel and sub-pixels defects of the same type that are nearby one another may be more noticeable, Philips also specifies tolerances for the proximity of pixel defects. In the table below you can find specifications about:

- Allowed amount of adjacent dark dots = (adjacent dark dots = 1 pair of dark dots)
- Minimum distance between dark dots
- Total no. of all defective dots

## 9.6. Pixel Defect Tolerances

In order to qualify for repair due to pixel defects during the warranty period, a PDP / TFT panel in a Philips Plasma / LCD- display must have pixel or sub-pixel defects exceeding the tolerances listed in the following table.

BRIGHT DOT EFFECT	ACCEPTABLE LEVEL
1 lit sub pixel	2
BLACK DOT EFFECT	ACCEPTABLE LEVEL
1 dark sub pixel	10
TOTAL DOT DEFECTS OF ALL TYPES	12

NOTE: \* 1 or 2 adjacent sub pixel defects = 1 dot defect

## 9.7. MURA

Dark spots or patches may occasionally appear on some liquid crystal display (LCD) panels. This is known within the industry as Mura, which is a Japanese term for "unevenness." It is used to describe an irregular pattern or area in which uneven screen uniformity appears under certain conditions. Mura is a result of the deterioration of the liquid crystal alignment layer and is most commonly caused by long-term operation under high ambient temperatures. It is an industry- wide phenomenon and Mura is not repairable. It is also not covered by our warranty terms.

Mura has been around since the introduction of LCD technology and with screens getting bigger and in operation 24/7, many displays are running in low light conditions. This all adds to the possibility of Mura affecting displays.

### HOW TO SPOT MURA

There are many symptoms of Mura and also multiple causes. Several of these are listed below:

- Impurities or foreign particles in the crystal matrix
- Uneven distribution of LCD matrix during manufacturing
- Non-uniform luminance distribution of the backlight
- Panel assembly induced stress
- Flaws within the LCD cells
- Thermal induced stress - high temperature operation over long periods of time

### HOW TO AVOID MURA

Although we can not guarantee the complete eradication of Mura every time, in general the appearance of Mura can be minimized by these methods:

- Lower the backlight brightness
- Use a screen saver
- Reduce the ambient temperature around the unit

## 10. Cleaning and Troubleshooting

### 10.1. Cleaning

#### Caution When Using the Display

- Do not bring your hands, face or objects close to the ventilation holes of the display. The top of the display is usually very hot due to the high temperature of exhaust air being released through the ventilation holes. Burns or personal injuries may occur if any body parts are brought too close. Placing any object near the top of the display could also result in heat related damage to the object as well as the display itself.
- Be sure to disconnect all cables before moving the display. Moving the display with its cables attached may damage the cables and thus cause fire or electric shock.
- Disconnect the power plug from the wall outlet as a safety precaution before carrying out any type of cleaning or maintenance procedure.

#### Front Panel Cleaning Instructions

- The front of the display has been specially treated. Wipe the surface gently using only a cleaning cloth or a soft, lint-free cloth.
- If the surface becomes dirty, soak a soft, lint-free cloth in a mild detergent solution. Wring the cloth to remove excess liquid. Wipe the surface of the display to remove dirt. Then use a dry cloth of the same type to dry.
- Do not scratch or hit the surface of the panel with fingers or hard objects of any kind.
- Do not use volatile substances such as insect sprays, solvents and thinners.

#### Cabinet Cleaning Instructions

- If the cabinet becomes dirty, wipe the cabinet with a soft, dry cloth.
- If the cabinet is extremely dirty, soak a lint-free cloth in a mild detergent solution. Wring the cloth to remove as much moisture as possible. Wipe the cabinet. Use another dry cloth to wipe over until the surface is dry.
- Do not allow any water or detergent to come into contact with the surface of the display. If water or moisture gets inside the unit, operating problems, electrical and shock hazards may result.
- Do not scratch or hit the cabinet with fingers or hard objects of any kind.
- Do not use volatile substances such as insect sprays, solvents and thinners on the cabinet.
- Do not place anything made from rubber or PVC near the cabinet for any extended periods of time.

## 10.2. Troubleshooting

Symptom	Possible Cause	Remedy
No picture is displayed	<ol style="list-style-type: none"> <li>1. The power cord is disconnected.</li> <li>2. The main power switch on the back of the display is not switched on.</li> <li>3. The selected input has no connection.</li> <li>4. The display is in standby mode.</li> </ol>	<ol style="list-style-type: none"> <li>1. Plug in the power cord.</li> <li>2. Make sure the power switch is switched on.</li> <li>3. Connect a signal connection to the display.</li> </ol>
Interference displayed on the display or audible noise is heard	Caused by surrounding electrical appliances or fluorescent lights.	Move the display to another location to see if the interference is reduced.
Color is abnormal	The signal cable is not connected properly.	Make sure that the signal cable is attached firmly to the back of the display.
Picture is distorted with abnormal patterns	<ol style="list-style-type: none"> <li>1. The signal cable is not connected properly.</li> <li>2. The input signal is beyond the capabilities of the display.</li> </ol>	<ol style="list-style-type: none"> <li>1. Make sure that the signal cable is attached firmly.</li> <li>2. Check the video signal source to see if it is beyond the range of the display. Please verify its specifications with this display's specification section.</li> </ol>
Display image doesn't fill up the full size of the screen	<ol style="list-style-type: none"> <li>1. The zoom mode is not set correctly.</li> <li>2. Scan Mode may be set incorrectly to underscan.</li> <li>3. If the image exceeds the screen size, Scan Mode may need to be set to Underscan.</li> </ol>	Use the Zoom mode or Custom zoom function in the Screen menu to fine tune display geometry and time frequency parameter.
Can hear sound, but no picture	Improperly connected source signal cable.	Make sure that both video inputs and sound inputs are correctly connected.
Can see picture but no sound is heard	<ol style="list-style-type: none"> <li>1. Improperly connected source signal cable.</li> <li>2. Volume is turned all the way down.</li> <li>3. {Mute} is turned on.</li> <li>4. No external speaker connected.</li> </ol>	<ol style="list-style-type: none"> <li>1. Make sure that both video inputs and sound inputs are correctly connected.</li> <li>2. Press <b>[+]</b> or <b>[-]</b> button to hear sound.</li> <li>3. Switch MUTE off by using the <b>[MUTE]</b> button.</li> <li>4. Connect external speakers and adjust the volume to a suitable level.</li> </ol>
Some picture elements do not light up	Some pixels of the display may not turn on.	This display is manufactured using an extremely high level of precision technology; however, sometimes some pixels of the display may not display. This is not a malfunction.
After-Images can still be seen on the display after the display is powered off. (Examples of still pictures include logos, video games, computer images, and images displayed in 4:3 normal mode)	A still picture is displayed for an over extended period of time	Do not allow a still image to be displayed for an extended period of time as this can cause a permanent after-image to remain on the display.

<p><b>How to setup the settings in the menu to control all the monitors at the same time and individually via RC?</b></p>	<p>Daisy chained by RS232 and no IR cable</p>	<p>1. The first display sets as "Primary" on OSD (Advanced option/IR control item), others set as "Secondary".</p> <p>2. The setup OSD will show on Top-Left of display. (Toggle MENU will show again if it disappear)</p> <p>3. Default setting: ID NO: 0, GP NO: 0, this setting can control all displays by IR.</p> <p>The "+", "-" can change "ID NO" to control signal display by "Monitor ID".</p> <p>The "UP", "DOWN" can change "GP NO" to control multi-display by "Group ID".</p> <p>*The first display always be controlled by IR.</p>
<p><b>How is the RC working?</b></p>	<p>Daisy chain : no RS232 connected and IR cable</p>	<p>No need setting, just to connect with IR cables and control by IR.</p> <p>*This way has out-of-synchronizm phenomenon. Suggest to use above setting with RS-232 cable.</p>

# 11. Technical Specifications

## Display:

Item	Specifications
Screen Size (Active Area)	123.2 cm / 48.5 inch
Aspect Ratio	16:9
Number of pixels	3840 (H) × 2160 (V)
Pixel pitch	0.315 (H) × 0.315 (V) [mm]
Displayable colors	10 bits(D), 1.07 Billion colors
Brightness (typical)	350 cd/m <sup>2</sup>
Contrast ratio (typical)	4000:1
Viewing angle	178 degrees

## In/Out Terminals:

Item	Specifications
Speaker Output	Internal Speakers 10W (L) + 10W (R) [RMS]/8Ω 82 dB/W/M/160 Hz ~ 13 KHz
Audio Output	RCA R/L × 1 0.5V [rms] (Normal) / 2 Channel (L+R)
Audio Input	3.5mm phone jack × 1 0.5V [rms] (Normal) / 2 Channel (L+R)
RS232C	2.5mm Phone jack × 2 RS232C in/RS232C out
RJ-45	RJ-45 Jack × 1 (8 pin) 10/100 LAN Port
HDMI Input	HDMI Jack × 2 (Type A) (19 pin) Digital RGB: TMDS (Video + Audio) MAX: Video - 720p, 1080p, 3840 × 2160/60 Hz Audio - 48 KHz/ 2 Channel (L+R) Supports LPCM only
VGA Input	D-SUB jack (15pin) Digital RGB: TMDS (Video) Analog RGB: 0.7V [p-p] (75Ω), H/CSV: TTL (2.2kΩ), SOG: 1V [p-p] (75Ω) MAX: 1920 × 1080/60 Hz (WUXGA)
DVI-D Input	DVI-D Jack Digital RGB: TMDS (Video)
IR Input/Output	3.5mm × 2 IR pass through or IR daisy chain
USB Input	USB × 2 (Type A) USB 2.0, Multimedia play and service port / USB 3.0, Multimedia play only

**General:**

Item	Specifications
Power Input	100 - 240V~, 50 - 60Hz, 2.5A
Power Consumption (Max)	175 W
Power Consumption (typ.)	140 W
Power Consumption (Standby & Off)	<0.5 W
Dimensions (Without Stand) [W x H x D]	1099.2 x 631.9 x 62.4 mm
Weight (Without Stand)	11.4 Kg
Gross Weight (Without Stand)	15.5 Kg

**Product Fiche :**

Item	Specifications
Energy Efficiency Class	B
Visible Screen Size	123.2 cm / 48.5 inch
On Mode Power Consumption (W)	125 W
Annual Energy Consumption (kWh)	183 kWh
Standby Power Consumption (W)	0.50 W
Off Mode Power Consumption (W)	0.50 W
Display Resolution (Pixels)	3840 x 2160
Network Standby (W)	0.45 W

**Environmental Condition:**

Item		Specifications
Temperature	Operational	0 ~ 40°C
	Storage	-20 ~ 60°C
Humidity	Operational	20 ~ 80% RH (No condensation)
	Storage	5 ~ 95% RH (No condensation)
Altitude	Operational	0 ~ 3,000 m
	Storage / Shipment	0 ~ 9,000 m



2017 © Koninklijke Philips N.V. All rights reserved.

Philips and the Philips Shield Emblem are registered trademarks of Koninklijke Philips N.V. and are used under license from Koninklijke Philips N.V.

Specifications are subject to change without notice.